

**Constant current independent dimmable driver**  
**DUL Series suffix DP(DALI-2+pushDIM+1-10V/10V PWM/Rx+EL+CLO+corridorDIM+DALI Programmable)**



**Features**

- Support DALI-2+pushDIM+1-10V/10V PWM/Rx dimming mode
- Support advanced functions such as corridorDIM,EL, CLO
- The output current programming can be realized through the DALI interface
- 10/16-level current output can be realized by DIP-switch
- Soft dimming and flicker-free at any brightness, meets the new requirements of ErP certification
- Using HPC patented technology, at any dimming level, the brightness of the lights is the same
- Dimming range 1~100%, output current accuracy 2%
- Standby power input<0.5W, meets the requirements of ErP certification
- High PF, high efficiency, low THD
- Screw-free and pressing type strain relief, supports thicker cables and is easier to install
- Intelligent LED hot-plug protection function
- SELV and Class II design, suitable for use outside of the light
- Compliance with CE,ENEC,UKCA,RCM,CCC,DALI-2 and other certifications
- IP20 protection grade, indoor use
- Nominal life-time up to 100,000 h
- 5-year guarantee

**Interfaces**

- DALI-2(DT6)
- PUSH(pushDIM)
- 1-10V 3in1(1-10V/10V PWM/Rx)

**Functions**

- Support central emergency application (dimming normal in DC input)
- Support self-contained emergency application
- Emergency lighting(EL)
- Constant light output function(CLO)
- Corridor dimming (corridorDIM)
- Programming via DALI(EasySet)
- Protective features (short-circuit, overload,no-load, hot plug-in protection )

**Suitable for lights**

- Suitable for lights with independent drivers such as downlights, spotlights, panel lights, etc
- Not suitable for lights with built-in drivers

**Typical applications**

- LED indoor lighting
- LED office lighting
- LED commercial lighting



## Model coding rules of DUL series

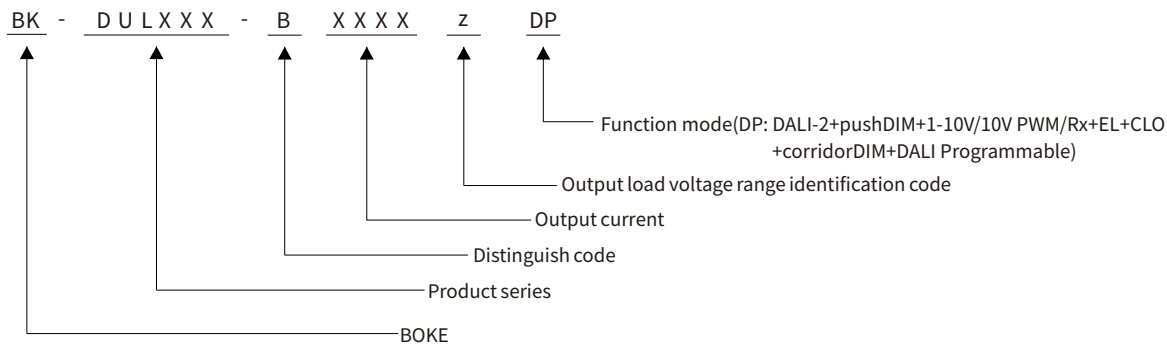

## Function list

Model	suffix	Wired dimming			Advanced functions				Device Configuration	
		DALI-2	pushDIM	1-10V	corridorDIM	AOC	EL	CLO	DALI interfaces	NFC interfaces
BK-DUL010-B BK-DUL022-B BK-DUL028-B BK-DUL030-B BK-DUL042-B BK-DUL060-B	DP	√	√	√	√	√	√	√	√	
	DF	√	√	√	√	√	√	√	√	√

\* The description in this specification is only applicable to the products with the suffix DP and the model are DUL010-B,DUL022-B,DUL028-B, DUL030-B, DUL042-B and DUL060-B.

## Model list

Model	Input voltage	Output power	Output voltage	Output current	Dimension	Certifications
BK-DUL010-B0350ADP	200-240VAC/DC	11W MAX.	6-30/36/40/42VDC	0.10-0.35A	L117*W45.5*H24mm	CE, ENEC, UKCA, RCM, CCC, EL, DALI-2
BK-DUL010-B0350ADF	200-240VAC/DC	11W MAX.	6-30/36/40/42VDC	0.10-0.35A	L117*W45.5*H24mm	CE, ENEC, UKCA, RCM, CCC, EL, DALI-2
BK-DUL022-B0600ADP	200-240VAC/DC	23.1W MAX.	6-38/42VDC	0.225-0.60A	L117*W45.5*H29mm	CE, ENEC, UKCA, RCM, CCC, EL, DALI-2
BK-DUL022-B0600ADF	200-240VAC/DC	23.1W MAX.	6-38/42VDC	0.225-0.60A	L117*W45.5*H29mm	CE, ENEC, UKCA, RCM, CCC, EL, DALI-2
BK-DUL028-B0750ADP	200-240VAC/DC	28.5W MAX.	6-38/40/42VDC	0.30-0.75A	L117*W45.5*H29mm	CE, ENEC, UKCA, RCM, CCC, EL, DALI-2
BK-DUL028-B0750ADF	200-240VAC/DC	28.5W MAX.	6-38/40/42VDC	0.30-0.75A	L117*W45.5*H29mm	CE, ENEC, UKCA, RCM, CCC, EL, DALI-2
BK-DUL030-B0800ADP	200-240VAC/DC	30.4W MAX.	6-38/40/42VDC	0.25-0.80A	L103*W68.5*H31mm	CE, ENEC, UKCA, RCM, CCC, EL, DALI-2
BK-DUL030-B0800ADF	200-240VAC/DC	30.4W MAX.	6-38/40/42VDC	0.25-0.80A	L103*W68.5*H31mm	CE, ENEC, UKCA, RCM, CCC, EL, DALI-2
BK-DUL042-B1100ADP	200-240VAC/DC	42W MAX.	6-38/40/42VDC	0.45-1.10A	L103*W68.5*H31mm	CE, ENEC, UKCA, RCM, CCC, EL, DALI-2
BK-DUL042-B1100ADF	200-240VAC/DC	42W MAX.	6-38/40/42VDC	0.45-1.10A	L103*W68.5*H31mm	CE, ENEC, UKCA, RCM, CCC, EL, DALI-2
BK-DUL060-B2000ADP	200-240VAC/DC	61.2W MAX.	6-30/32/34/36/38/40/42VDC	0.80-2.00A	L123.5*W79.5*H31mm	CE, ENEC, UKCA, RCM, CCC, EL, DALI-2
BK-DUL060-B2000ADF	200-240VAC/DC	61.2W MAX.	6-30/32/34/36/38/40/42VDC	0.80-2.00A	L123.5*W79.5*H31mm	CE, ENEC, UKCA, RCM, CCC, EL, DALI-2

\* The description in this specification is only applicable to the products with the suffix DP and the model are DUL010-B,DUL022-B,DUL028-B, DUL030-B, DUL042-B and DUL060-B.

**Technical data**

Product model	BK-DUL010-B0350ADP
<b>Output parameters</b>	
Regulation method	Constant Current
Rated output current range	0.1-0.35A
Rated output voltage range	6-30/36/40/42VDC
Rated output power	11W Max
Output current adjustment	DIP S.W(10 levels)
Output current ripple LF	±2%
Output current accuracy	±2%
Linear regulation	±1%
Load regulation	±1%
No load output voltage	50VDC
Flicker-free(typical)	Flickering percent(IEEE 1789)=0.193%, Flicker index(IEEE 1789)=0.001, Pst LM = 0.000, SVM = 0.004, (The above parameters are obtained from testing the panel lights)
<b>Input parameters</b>	
Rated input voltage range	200-240VAC 200-240VDC
Input voltage range	180-264VAC 200-264VDC
Input voltage shock	<380 VAC
Input current	<0.07A (Rated input voltage)
Input frequency	0/50/60Hz
Input PF/Input DF	PF: 0.96, DF: 0.96 ,see the electrical values below for details
Input THD	9% ,see the electrical values below for details
Efficiency(Max)	85% ,see the electrical values below for details
In-rush current	3.79A peak ,170us duration(50 % Ipeak), see the description below for details
Start/Switchover/Turn off	<0.7s(AC start),<0.7s(DC start),<0.3s(AC/DC switchover),<0.5s(Turn off )
Switching cycles	> 50,000 switching cycles
Power consumption	Full load(Pin):12.9W, No load(Pno): N/A, On stand-by(Psb) : <0.5W, Network stand-by(Pnet) : N/A
<b>Safety</b>	
Withstand voltage	I/P-O/P(LED):3750V AC, I/P-DALI: 1500V AC, O/P-DALI: 1500V AC.
Mains surge capability	L-N:2KV(Performance criterion:A)
Leakage current	0.31mA (230V AC & Full load)
Isolation resistance	I/P-O/P:100MΩ/500Vdc/25°C/70% RH
<b>Control interface</b>	
DALI dimming port	Voltage range: 9.5-22.5V, typical 16V, interface current consumption: 1.8mA
pushDIM dimming port	Voltage range: 180-264V 47/63Hz
1-10V dimming port(Non-isolated)	Voltage range: 0-10V, Maximum output current: ≤0.3mA
Auxiliary power supply	N/A
Dimming range	1-100%
Dimming drive mode	AM(amplitude modulation)
<b>Emergency support</b>	
Central emergency system	Supported(dimming normal in DC input)
Self-contained emergency	Supported
<b>Environment &amp; Life time</b>	
Operating temperature	Ta=-20-60°C
Case temperature	Tc=90°C
Operating humidity	5-85% RH, not condensed
Storage temp./humidity	-40-80°C, 5-85% RH, not condensed
IP grade	IP20
MTBF	500,000H,MIL-HDBK-217F(25°C)
Life-time	Nominal life-time up to 100,000 h, see the description below for details
Vibration resistant	10~500Hz,5G 12min./1cycle,period for 72min. each along X,Y,Z axes
Acoustic Noise	<25dB(30cm, Normal operation)
Environmental protection	RoHS
<b>Certifications and standards</b>	
Certifications	CE, ENEC, UKCA, RCM, CCC, EL, DALI-2
Safety	EN61347-1, EN61347-2-13, EN62384
EMC	EN55015, EN61000-3-2 , EN61000-3-3, EN61000-4-2,3,4,5,6,8,11, EN61547
DALI-2	IEC 62386-101(DALI-2), IEC 62386-102(DALI-2), IEC 62386-207(DALI-2)
EL	Compatible IEC 61347-2- 13 Annex J, compatible with EN 60598-2-22 and EN 50172
RF	N/A

**Remarks**

- 1.By default, all parameter are measured at 230VAC input, full load and 25°C of ambient temperature.
- 2.The driver can not be installed inside the light. when the driver is used with the light, the EMC of the whole light needs to be tested.

## Technical data

Product model	BK-DUL022-B0600ADP
<b>Output parameters</b>	
Regulation method	Constant Current
Rated output current range	0.225-0.6A
Rated output voltage range	6-38/42VDC
Rated output power	23.1W Max
Output current adjustment	DIP S.W(10 levels)
Output current ripple LF	±2%
Output current accuracy	±2%
Linear regulation	±1%
Load regulation	±1%
No load output voltage	50VDC
Flicker-free(typical)	Flickering percent(IEEE 1789)=0.184%, Flicker index(IEEE 1789)=0.003, Pst LM = 0.000, SVM = 0.004, (The above parameters are obtained from testing the panel lights)
<b>Input parameters</b>	
Rated input voltage range	200-240VAC 200-240VDC
Input voltage range	180-264VAC 200-264VDC
Input voltage shock	<380 V AC
Input current	<0.14A (Rated input voltage)
Input frequency	0/50/60Hz
Input PF/Input DF	PF: 0.98, DF: 0.98 ,see the electrical values below for details
Input THD	8% ,see the electrical values below for details
Efficiency(Max)	86% ,see the electrical values below for details
In-rush current	6.28A peak ,206us duration(50 % Ipeak), see the description below for details
Start/Switchover/Turn off	<0.7s(AC start),<0.7s(DC start),<0.3s(AC/DC switchover),<0.5s(Turn off )
Switching cycles	> 50,000 switching cycles
Power consumption	Full load(Pin):26.9W, No load(Pno): N/A, On stand-by(Psb) : <0.5W, Network stand-by(Pnet) : N/A
<b>Safety</b>	
Withstand voltage	I/P-O/P(LED):3750V AC, I/P-DALI: 1500V AC, O/P-DALI: 1500V AC.
Mains surge capability	L-N:2KV(Performance criterion:A)
Leakage current	0.34mA (230V AC & Full load)
Isolation resistance	I/P-O/P:100MΩ/500Vdc/25°C/70% RH
<b>Control interface</b>	
DALI dimming port	Voltage range: 9.5-22.5V, typical 16V, interface current consumption: 1.8mA
pushDIM dimming port	Voltage range: 180-264V 47/63Hz
1-10V dimming port(Non-isolated)	Voltage range: 0-10V, Maximum output current: ≤0.3mA
Auxiliary power supply	N/A
Dimming range	1-100%
Dimming drive mode	AM(amplitude modulation)
<b>Emergency support</b>	
Central emergency system	Supported(dimming normal in DC input)
Self-contained emergency	Supported
<b>Environment &amp; Life time</b>	
Operating temperature	Ta=-20-50°C
Case temperature	Tc=90°C
Operating humidity	5-85% RH, not condensed
Storage temp./humidity	-40-80°C, 5-85% RH, not condensed
IP grade	IP20
MTBF	500,000H,MIL-HDBK-217F(25°C)
Life-time	Nominal life-time up to 100,000 h, see the description below for details
Vibration resistant	10~500Hz,5G 12min./1cycle,period for 72min. each along X,Y,Z axes
Acoustic Noise	<25dB(30cm, Normal operation)
Environmental protection	RoHS
<b>Certifications and standards</b>	
Certifications	CE, ENEC, UKCA, RCM, CCC, EL, DALI-2
Safety	EN61347-1, EN61347-2-13, EN62384
EMC	EN55015, EN61000-3-2 , EN61000-3-3, EN61000-4-2,3,4,5,6,8,11, EN61547
DALI-2	IEC 62386-101(DALI-2), IEC 62386-102(DALI-2), IEC 62386-207(DALI-2)
EL	Compatible IEC 61347-2- 13 Annex J, compatible with EN 60598-2-22 and EN 50172
RF	N/A

## Remarks

- 1.By default, all parameter are measured at 230VAC input, full load and 25°C of ambient temperature.
- 2.The driver can not be installed inside the light. when the driver is used with the light, the EMC of the whole light needs to be tested.

**Technical data**

Product model	BK-DUL028-B0750ADP
<b>Output parameters</b>	
Regulation method	Constant Current
Rated output current range	0.3-0.75A
Rated output voltage range	6-38/40/42VDC
Rated output power	28.5W Max
Output current adjustment	DIP S.W(10 levels)
Output current ripple LF	±2%
Output current accuracy	±2%
Linear regulation	±1%
Load regulation	±1%
No load output voltage	50VDC
Flicker-free(typical)	Flickering percent(IEEE 1789)=0.232%, Flicker index(IEEE 1789)=0.003, Pst LM = 0.02, SVM = 0.006, (The above parameters are obtained from testing the panel lights)
<b>Input parameters</b>	
Rated input voltage range	200-240VAC 200-240VDC
Input voltage range	180-264VAC 200-264VDC
Input voltage shock	<380 V AC
Input current	<0.18A (Rated input voltage)
Input frequency	0/50/60Hz
Input PF/Input DF	PF: 0.97, DF: 0.98 ,see the electrical values below for details
Input THD	6% ,see the electrical values below for details
Efficiency(Max)	85.5% ,see the electrical values below for details
In-rush current	6.25A peak ,212us duration(50 % Ipeak), see the description below for details
Start/Switchover/Turn off	<0.7s(AC start),<0.7s(DC start),<0.3s(AC/DC switchover),<0.5s(Turn off )
Switching cycles	> 50,000 switching cycles
Power consumption	Full load(Pin):33.3W, No load(Pno): N/A, On stand-by(Psb) : <0.5W, Network stand-by(Pnet) : N/A
<b>Safety</b>	
Withstand voltage	I/P-O/P(LED):3750V AC, I/P-DALI: 1500V AC, O/P-DALI: 1500V AC.
Mains surge capability	L-N:2KV(Performance criterion:A)
Leakage current	0.33mA (230V AC & Full load)
Isolation resistance	I/P-O/P:100MΩ/500Vdc/25°C/70% RH
<b>Control interface</b>	
DALI dimming port	Voltage range: 9.5-22.5V, typical 16V, interface current consumption: 1.8mA
pushDIM dimming port	Voltage range: 180-264V 47/63Hz
1-10V dimming port(Non-isolated)	Voltage range: 0-10V, Maximum output current: ≤0.3mA
Auxiliary power supply	N/A
Dimming range	1-100%
Dimming drive mode	AM(amplitude modulation)
<b>Emergency support</b>	
Central emergency system	Supported(dimming normal in DC input)
Self-contained emergency	Supported
<b>Environment &amp; Life time</b>	
Operating temperature	Ta=-20-45°C
Case temperature	Tc=90°C
Operating humidity	5-85% RH, not condensed
Storage temp./humidity	-40-80°C, 5-85% RH, not condensed
IP grade	IP20
MTBF	500,000H,MIL-HDBK-217F(25°C)
Life-time	Nominal life-time up to 100,000 h, see the description below for details
Vibration resistant	10~500Hz,5G 12min./1cycle,period for 72min. each along X,Y,Z axes
Acoustic Noise	<25dB(30cm, Normal operation)
Environmental protection	RoHS
<b>Certifications and standards</b>	
Certifications	CE, ENEC, UKCA, RCM, CCC, EL, DALI-2
Safety	EN61347-1, EN61347-2-13, EN62384
EMC	EN55015, EN61000-3-2 , EN61000-3-3, EN61000-4-2,3,4,5,6,8,11, EN61547
DALI-2	IEC 62386-101(DALI-2), IEC 62386-102(DALI-2), IEC 62386-207(DALI-2)
EL	Compatible IEC 61347-2- 13 Annex J, compatible with EN 60598-2-22 and EN 50172
RF	N/A

**Remarks**

- 1.By default, all parameter are measured at 230VAC input, full load and 25°C of ambient temperature.
- 2.The driver can not be installed inside the light. when the driver is used with the light, the EMC of the whole light needs to be tested.

**Technical data**

Product model	BK-DUL030-B0800ADP
<b>Output parameters</b>	
Regulation method	Constant Current
Rated output current range	0.25-0.8A
Rated output voltage range	6-38/40/42VDC
Rated output power	30.4W Max
Output current adjustment	DIP S.W(16 levels)
Output current ripple LF	±2%
Output current accuracy	±2%
Linear regulation	±1%
Load regulation	±1%
No load output voltage	50VDC
Flicker-free(typical)	Flickering percent(IEEE 1789)=0.073%, Flicker index(IEEE 1789)=0.000, Pst LM = 0.000, SVM = 0.002, (The above parameters are obtained from testing the panel lights)
<b>Input parameters</b>	
Rated input voltage range	200-240VAC 200-240VDC
Input voltage range	180-264VAC 200-264VDC
Input voltage shock	<380 V AC
Input current	<0.18A (Rated input voltage)
Input frequency	0/50/60Hz
Input PF/Input DF	PF: 0.98, DF: 0.98 ,see the electrical values below for details
Input THD	7% ,see the electrical values below for details
Efficiency(Max)	87.5% ,see the electrical values below for details
In-rush current	7.6A peak ,182us duration(50 % Ipeak), see the description below for details
Start/Switchover/Turn off	<0.7s(AC start),<0.7s(DC start),<0.3s(AC/DC switchover),<0.5s(Turn off )
Switching cycles	> 50,000 switching cycles
Power consumption	Full load(Pin):34.7W, No load(Pno): N/A, On stand-by(Psb) : <0.5W, Network stand-by(Pnet) : N/A
<b>Safety</b>	
Withstand voltage	I/P-O/P(LED):3750V AC, I/P-DALI: 1500V AC, O/P-DALI: 1500V AC.
Mains surge capability	L-N:2KV(Performance criterion:A)
Leakage current	0.42mA (230V AC & Full load)
Isolation resistance	I/P-O/P:100MΩ/500Vdc/25°C/70% RH
<b>Control interface</b>	
DALI dimming port	Voltage range: 9.5-22.5V, typical 16V, interface current consumption: 1.8mA
pushDIM dimming port	Voltage range: 180-264V 47/63Hz
1-10V dimming port(Non-isolated)	Voltage range: 0-10V, Maximum output current: ≤0.3mA
Auxiliary power supply	N/A
Dimming range	1-100%
Dimming drive mode	AM(amplitude modulation)
<b>Emergency support</b>	
Central emergency system	Supported(dimming normal in DC input)
Self-contained emergency	Supported
<b>Environment &amp; Life time</b>	
Operating temperature	Ta=-20-45°C
Case temperature	Tc=90°C
Operating humidity	5-85% RH, not condensed
Storage temp./humidity	-40-80°C, 5-85% RH, not condensed
IP grade	IP20
MTBF	500,000H,MIL-HDBK-217F(25°C)
Life-time	Nominal life-time up to 100,000 h, see the description below for details
Vibration resistant	10~500Hz,5G 12min./1cycle,period for 72min. each along X,Y,Z axes
Acoustic Noise	<25dB(30cm, Normal operation)
Environmental protection	RoHS
<b>Certifications and standards</b>	
Certifications	CE, ENEC, UKCA, RCM, CCC, EL, DALI-2
Safety	EN61347-1, EN61347-2-13, EN62384
EMC	EN55015, EN61000-3-2 , EN61000-3-3, EN61000-4-2,3,4,5,6,8,11, EN61547
DALI-2	IEC 62386-101(DALI-2), IEC 62386-102(DALI-2), IEC 62386-207(DALI-2)
EL	Compatible IEC 61347-2- 13 Annex J, compatible with EN 60598-2-22 and EN 50172
RF	N/A

**Remarks**

- 1.By default, all parameter are measured at 230VAC input, full load and 25°C of ambient temperature.
- 2.The driver can not be installed inside the light. when the driver is used with the light, the EMC of the whole light needs to be tested.

## Technical data

Product model	BK-DUL042-B1100ADP
<b>Output parameters</b>	
Regulation method	Constant Current
Rated output current range	0.45-1.1A
Rated output voltage range	6-38/40/42VDC
Rated output power	42W Max
Output current adjustment	DIP S.W(16 levels)
Output current ripple LF	±2%
Output current accuracy	±2%
Linear regulation	±1%
Load regulation	±1%
No load output voltage	50VDC
Flicker-free(typical)	Flickering percent(IEEE 1789)=0.143%, Flicker index(IEEE 1789)=0.000, Pst LM = 0.024, SVM = 0.003, (The above parameters are obtained from testing the panel lights)
<b>Input parameters</b>	
Rated input voltage range	200-240VAC 200-240VDC
Input voltage range	180-264VAC 200-264VDC
Input voltage shock	<380 VAC
Input current	<0.25A (Rated input voltage)
Input frequency	0/50/60Hz
Input PF/Input DF	PF: 0.97, DF: 0.98 ,see the electrical values below for details
Input THD	8.5% ,see the electrical values below for details
Efficiency(Max)	89% ,see the electrical values below for details
In-rush current	7.3A peak ,188us duration(50 % Ipeak), see the description below for details
Start/Switchover/Turn off	<0.7s(AC start),<0.7s(DC start),<0.3s(AC/DC switchover),<0.5s(Turn off )
Switching cycles	> 50,000 switching cycles
Power consumption	Full load(Pin):47.2W, No load(Pno): N/A, On stand-by(Psb) : <0.5W, Network stand-by(Pnet) : N/A
<b>Safety</b>	
Withstand voltage	I/P-O/P(LED):3750V AC, I/P-DALI: 1500V AC, O/P-DALI: 1500V AC.
Mains surge capability	L-N:2KV(Performance criterion:A)
Leakage current	0.25mA (230V AC & Full load)
Isolation resistance	I/P-O/P:100MΩ/500Vdc/25°C/70% RH
<b>Control interface</b>	
DALI dimming port	Voltage range: 9.5-22.5V, typical 16V, interface current consumption: 1.8mA
pushDIM dimming port	Voltage range: 180-264V 47/63Hz
1-10V dimming port(Non-isolated)	Voltage range: 0-10V, Maximum output current: ≤0.3mA
Auxiliary power supply	N/A
Dimming range	1-100%
Dimming drive mode	AM(amplitude modulation)
<b>Emergency support</b>	
Central emergency system	Supported(dimming normal in DC input)
Self-contained emergency	Supported
<b>Environment &amp; Life time</b>	
Operating temperature	Ta=-20-45°C
Case temperature	Tc=90°C
Operating humidity	5-85% RH, not condensed
Storage temp./humidity	-40-80°C, 5-85% RH, not condensed
IP grade	IP20
MTBF	500,000H,MIL-HDBK-217F(25°C)
Life-time	Nominal life-time up to 100,000 h, see the description below for details
Vibration resistant	10~500Hz,5G 12min./1cycle,period for 72min. each along X,Y,Z axes
Acoustic Noise	<25dB(30cm, Normal operation)
Environmental protection	RoHS
<b>Certifications and standards</b>	
Certifications	CE, ENEC, UKCA, RCM, CCC, EL, DALI-2
Safety	EN61347-1, EN61347-2-13, EN62384
EMC	EN55015, EN61000-3-2 , EN61000-3-3, EN61000-4-2,3,4,5,6,8,11, EN61547
DALI-2	IEC 62386-101(DALI-2), IEC 62386-102(DALI-2), IEC 62386-207(DALI-2)
EL	Compatible IEC 61347-2- 13 Annex J, compatible with EN 60598-2-22 and EN 50172
RF	N/A

## Remarks

- 1.By default, all parameter are measured at 230VAC input, full load and 25°C of ambient temperature.
- 2.The driver can not be installed inside the light. when the driver is used with the light, the EMC of the whole light needs to be tested.

## Technical data

Product model	BK-DUL060-B2000ADP
<b>Output parameters</b>	
Regulation method	Constant Current
Rated output current range	0.8-2A
Rated output voltage range	6-30/32/34/36/38/40/42VDC
Rated output power	61.2W Max
Output current adjustment	DIP S.W(16 levels)
Output current ripple LF	±2%
Output current accuracy	±2%
Linear regulation	±1%
Load regulation	±1%
No load output voltage	50VDC
Flicker-free(typical)	Flickering percent(IEEE 1789)=0.129%, Flicker index(IEEE 1789)=0.000, Pst LM = 0.007, SVM = 0.003, (The above parameters are obtained from testing the panel lights)
<b>Input parameters</b>	
Rated input voltage range	200-240VAC 200-240VDC
Input voltage range	180-264VAC 200-264VDC
Input voltage shock	<380 VAC
Input current	<0.36A (Rated input voltage)
Input frequency	0/50/60Hz
Input PF/Input DF	PF: 0.97, DF: 0.98 ,see the electrical values below for details
Input THD	7.5% ,see the electrical values below for details
Efficiency(Max)	90.5% ,see the electrical values below for details
In-rush current	14.1A peak ,194us duration(50 % Ipeak), see the description below for details
Start/Switchover/Turn off	<0.7s(AC start),<0.7s(DC start),<0.3s(AC/DC switchover),<0.5s(Turn off )
Switching cycles	> 50,000 switching cycles
Power consumption	Full load(Pin):66.5W, No load(Pno): N/A, On stand-by(Psb) : <0.5W, Network stand-by(Pnet) : N/A
<b>Safety</b>	
Withstand voltage	I/P-O/P(LED):3750V AC, I/P-DALI: 1500V AC, O/P-DALI: 1500V AC.
Mains surge capability	L-N:2KV(Performance criterion:A)
Leakage current	0.25mA (230V AC & Full load)
Isolation resistance	I/P-O/P:100MΩ/500Vdc/25°C/70% RH
<b>Control interface</b>	
DALI dimming port	Voltage range: 9.5-22.5V, typical 16V, interface current consumption: 1.8mA
pushDIM dimming port	Voltage range: 180-264V 47/63Hz
1-10V dimming port(Non-isolated)	Voltage range: 0-10V, Maximum output current: ≤0.3mA
Auxiliary power supply	N/A
Dimming range	1-100%
Dimming drive mode	AM(amplitude modulation)
<b>Emergency support</b>	
Central emergency system	Supported(dimming normal in DC input)
Self-contained emergency	Supported
<b>Environment &amp; Life time</b>	
Operating temperature	Ta=-20-45°C
Case temperature	Tc=90°C
Operating humidity	5-85% RH, not condensed
Storage temp./humidity	-40-80°C, 5-85% RH, not condensed
IP grade	IP20
MTBF	500,000H,MIL-HDBK-217F(25°C)
Life-time	Nominal life-time up to 100,000 h, see the description below for details
Vibration resistant	10~500Hz,5G 12min./1cycle,period for 72min. each along X,Y,Z axes
Acoustic Noise	<25dB(30cm, Normal operation)
Environmental protection	RoHS
<b>Certifications and standards</b>	
Certifications	CE, ENEC, UKCA, RCM, CCC, EL, DALI-2
Safety	EN61347-1, EN61347-2-13, EN62384
EMC	EN55015, EN61000-3-2 , EN61000-3-3, EN61000-4-2,3,4,5,6,8,11, EN61547
DALI-2	IEC 62386-101(DALI-2), IEC 62386-102(DALI-2), IEC 62386-207(DALI-2)
EL	Compatible IEC 61347-2- 13 Annex J, compatible with EN 60598-2-22 and EN 50172
RF	N/A

## Remarks

- 1.By default, all parameter are measured at 230VAC input, full load and 25°C of ambient temperature.
- 2.The driver can not be installed inside the light. when the driver is used with the light, the EMC of the whole light needs to be tested.

**Electrical values**

**BK-DUL010-B0350ADP**

Operating window

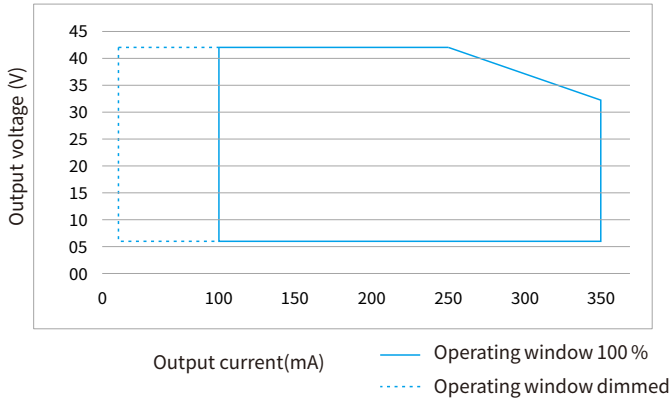

Operating window

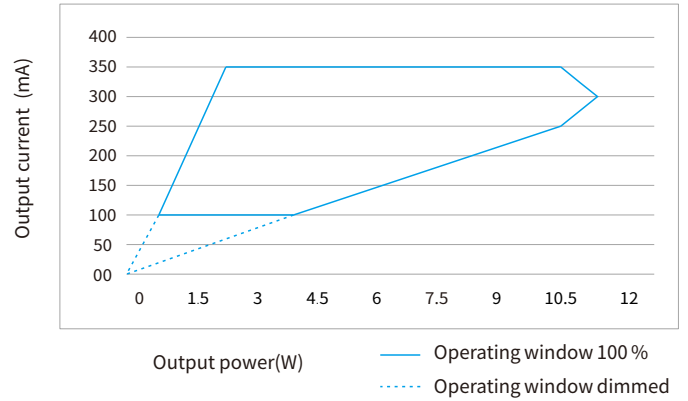

Efficiency vs load

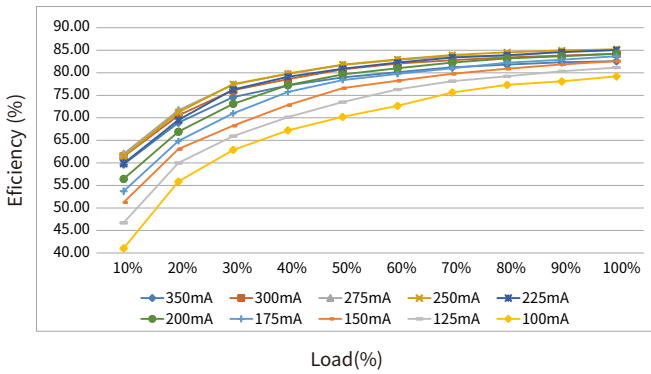

THD vs. Load

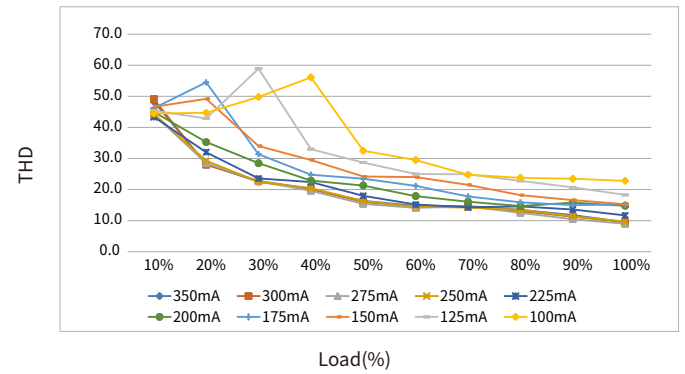

Power factor vs. Load

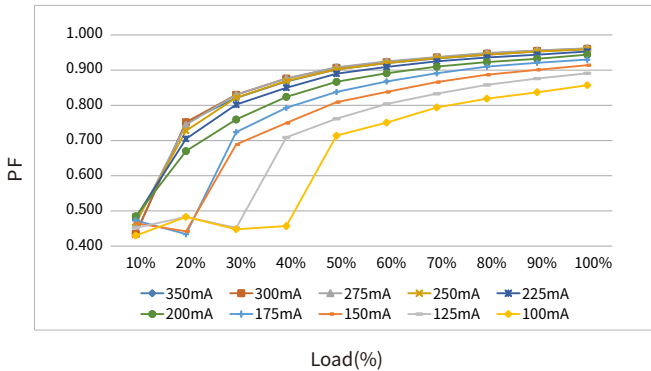

Displacement factor vs. Load

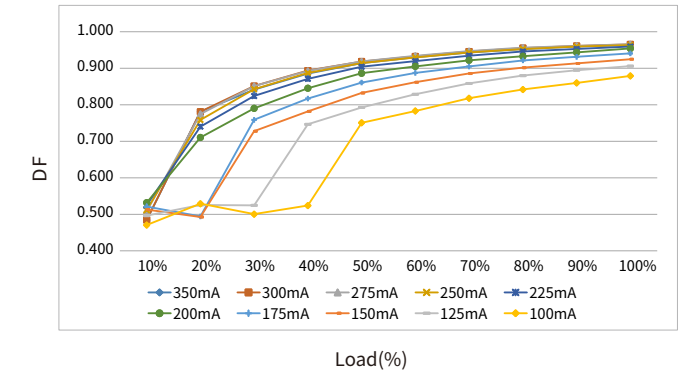

**Expected life-time**

Life-time vs. case temperature

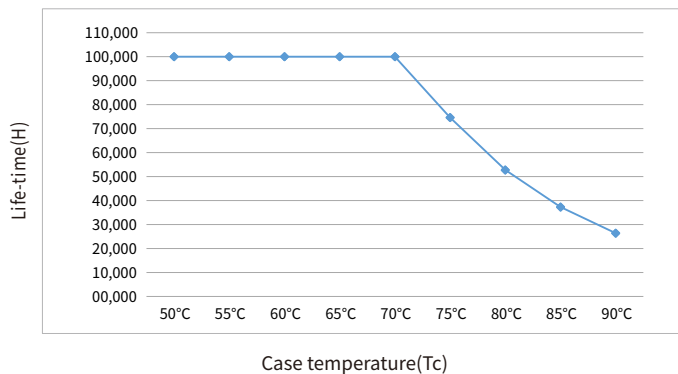

-The life-time of the LED driver is shown in the figure above (calculated based on the 90% survival rate).  
 - The relation of tc to ta temperature depends also on the luminaire design.

**Electrical values**

**BK-DUL022-B0600ADP**

Operating window

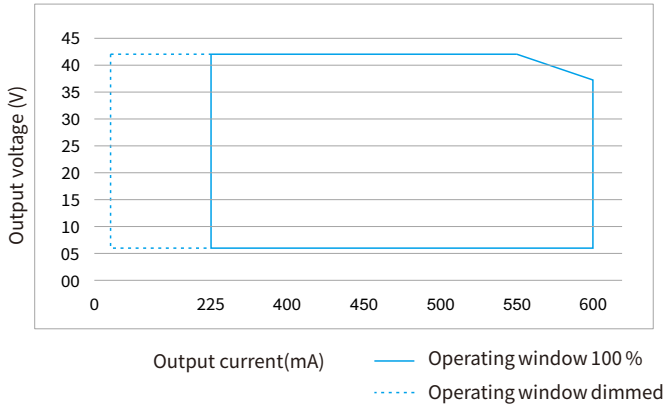

Operating window

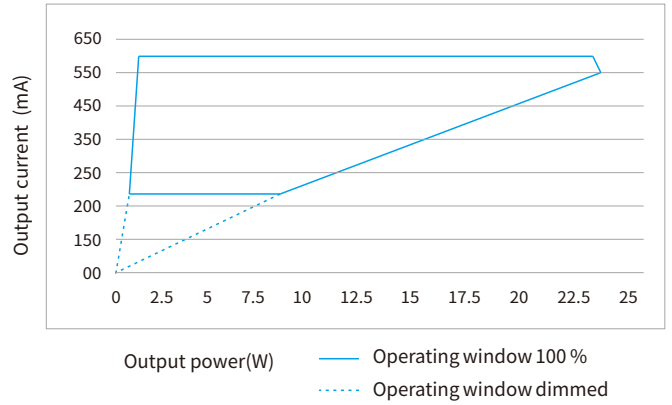

Efficiency vs load

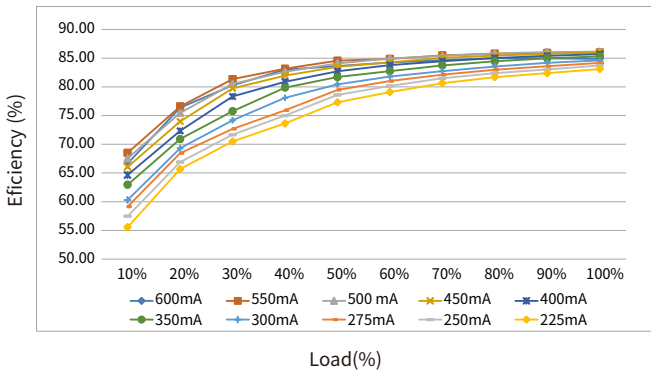

THD vs. Load

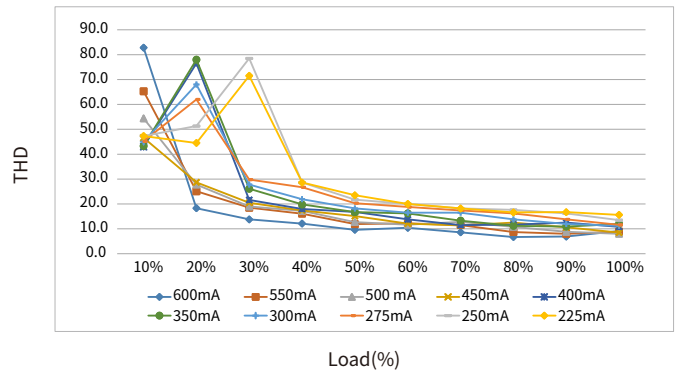

Power factor vs. Load

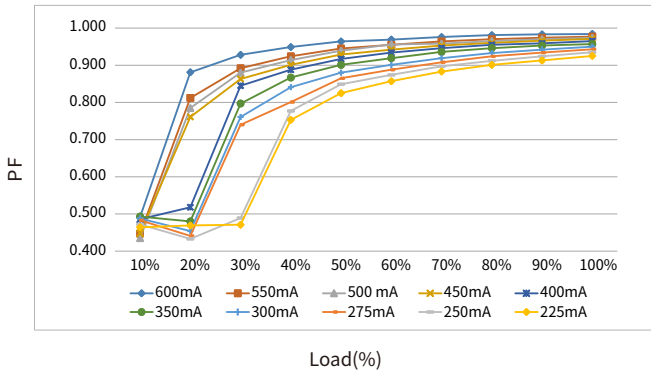

Displacement factor vs. Load

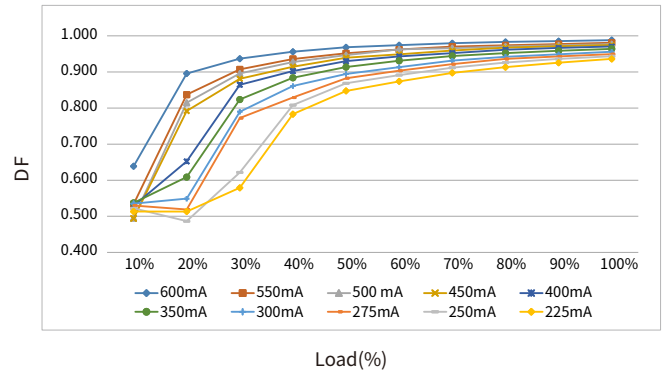

**Expected life-time**

Life-time vs. case temperature

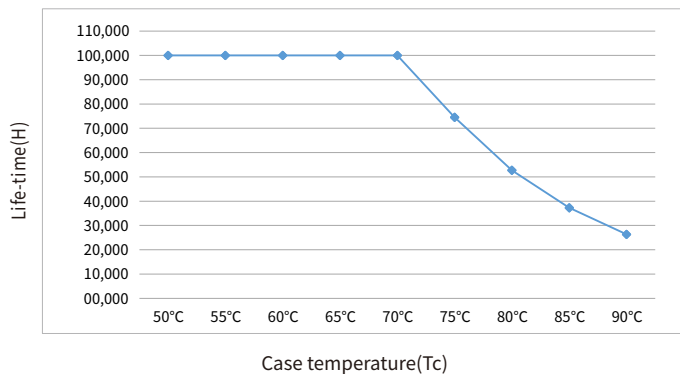

-The life-time of the LED driver is shown in the figure above (calculated based on the 90% survival rate).  
 - The relation of tc to ta temperature depends also on the luminaire design.

Electrical values

BK-DUL028-B0750ADP

Operating window

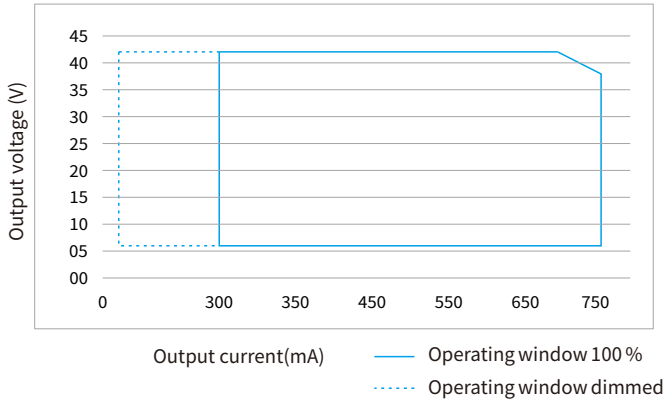

Operating window

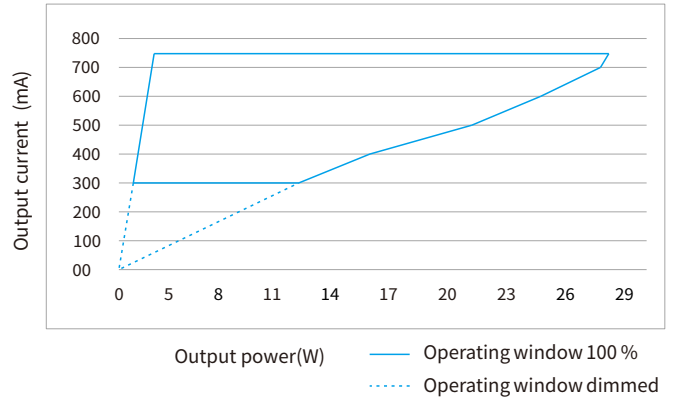

Efficiency vs load

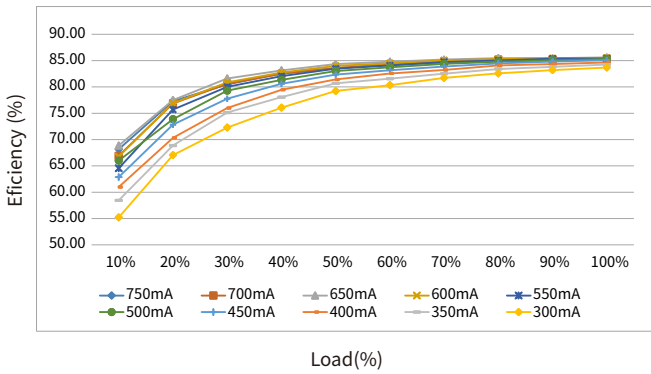

THD vs. Load

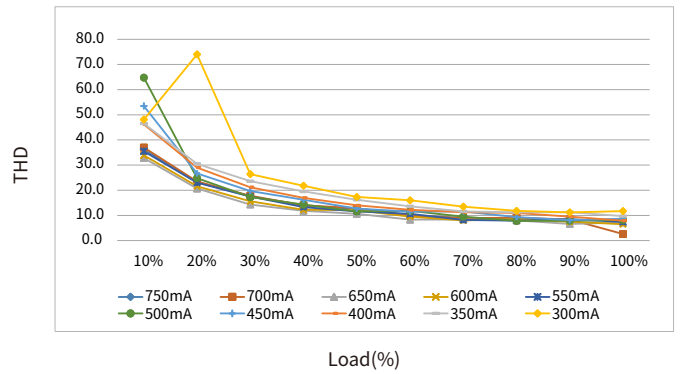

Power factor vs. Load

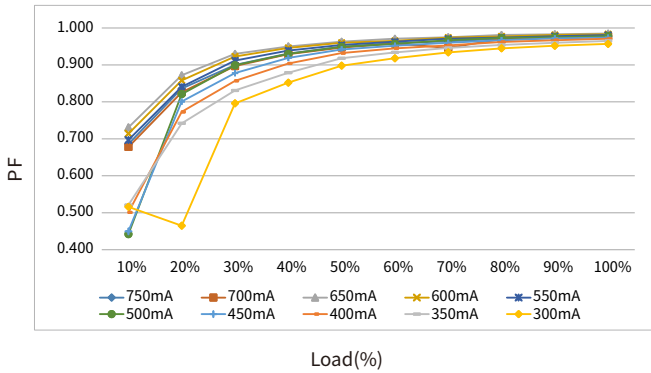

Displacement factor vs. Load

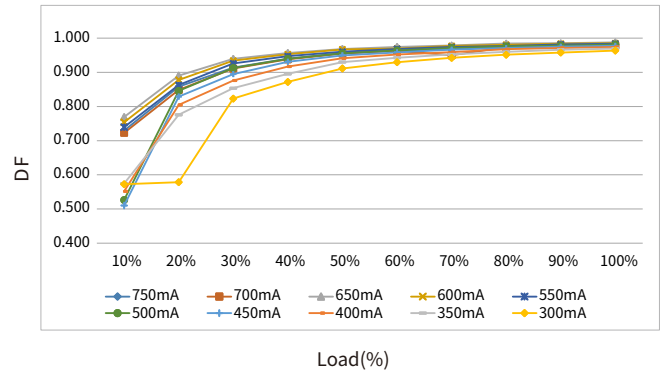

Expected life-time

Life-time vs. case temperature

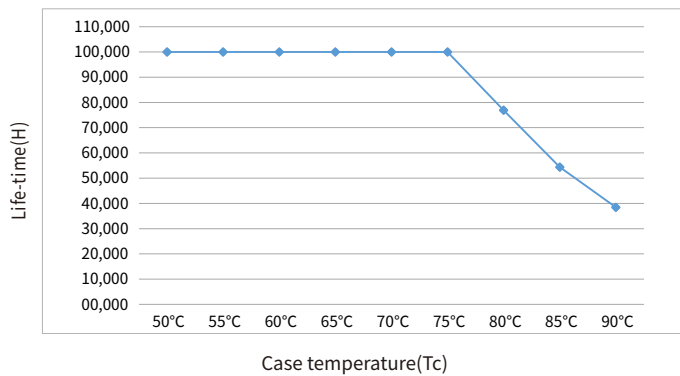

-The life-time of the LED driver is shown in the figure above (calculated based on the 90% survival rate).

- The relation of tc to ta temperature depends also on the luminaire design.

Electrical values

BK-DUL030-B0800ADP

Operating window

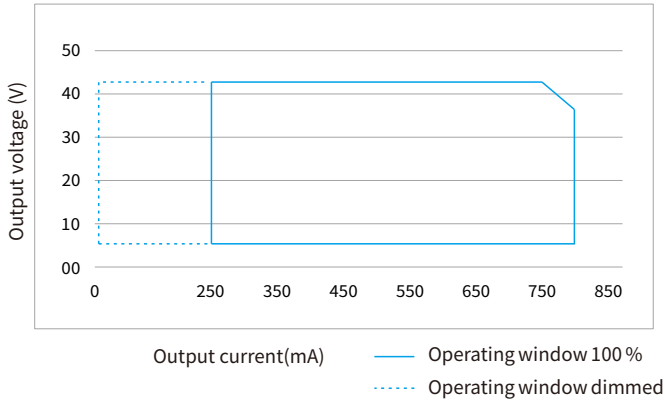

Operating window

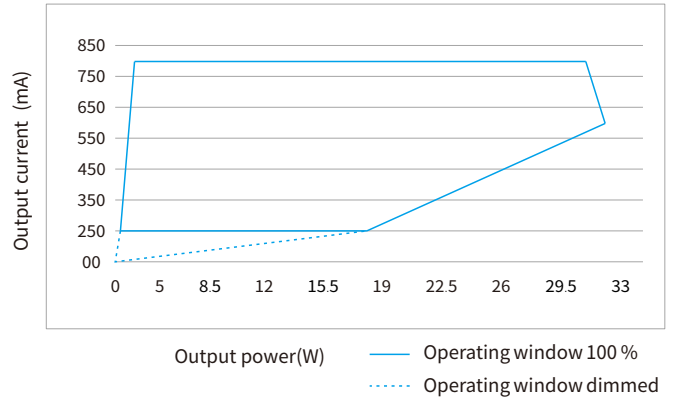

Efficiency vs load

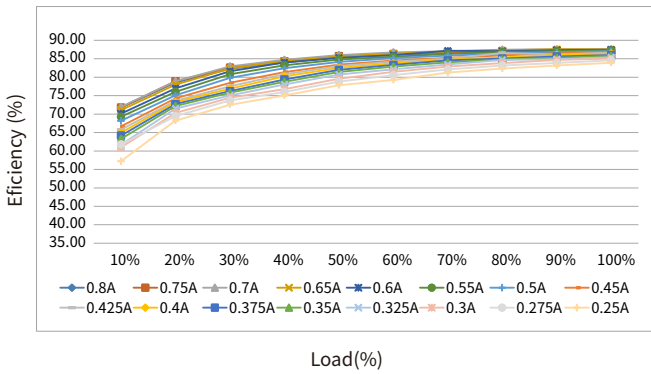

THD vs. Load

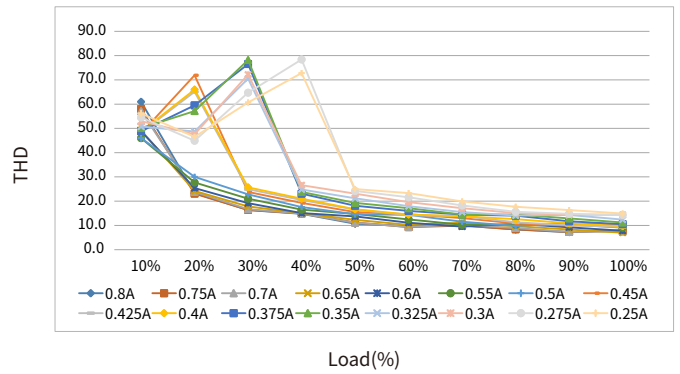

Power factor vs. Load

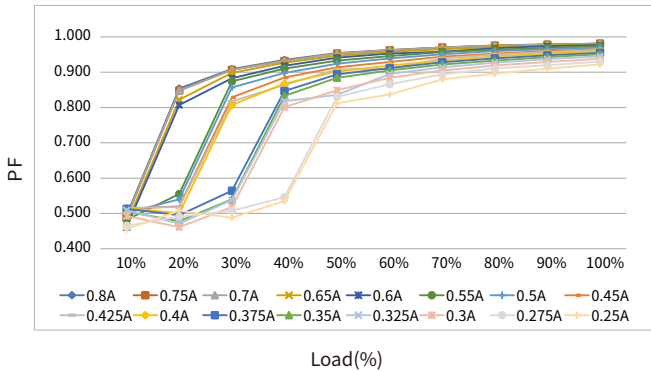

Displacement factor vs. Load

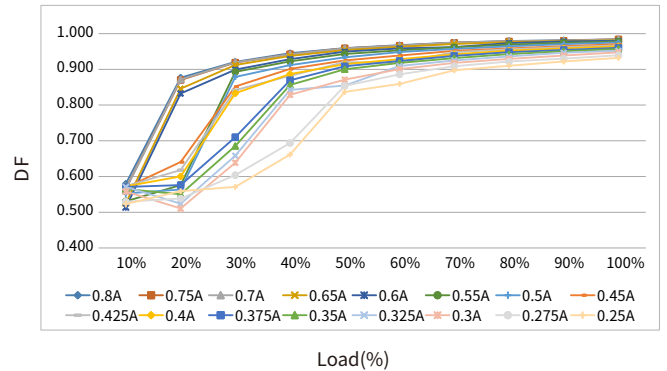

Expected life-time

Life-time vs. case temperature

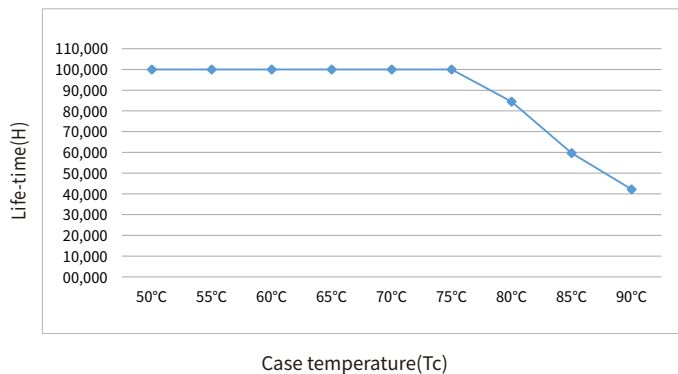

-The life-time of the LED driver is shown in the figure above (calculated based on the 90% survival rate).

- The relation of tc to ta temperature depends also on the luminaire design.

**Electrical values**

**BK-DUL042-B1100ADP**

Operating window

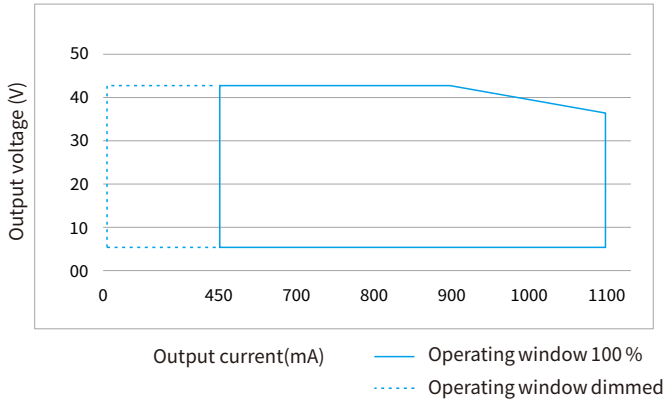

Operating window

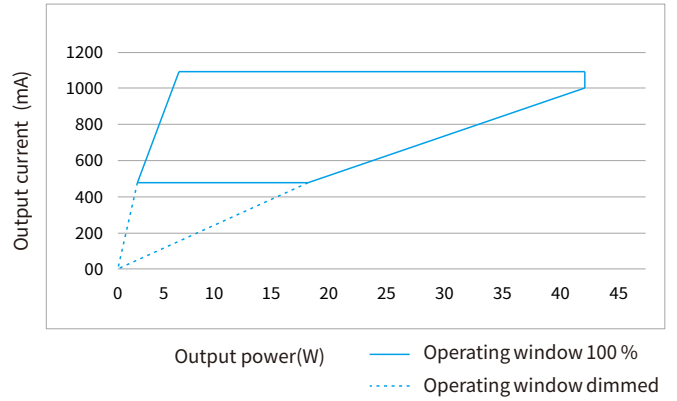

Efficiency vs load

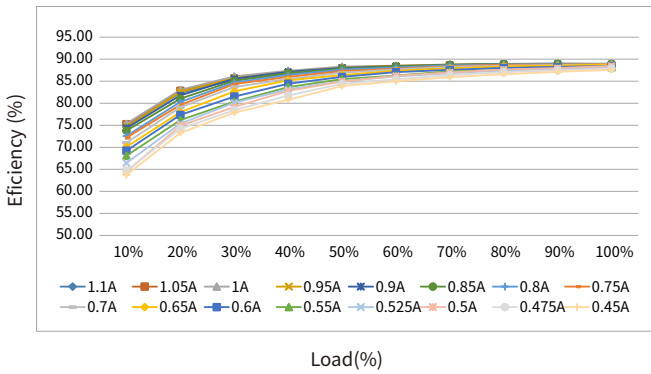

THD vs. Load

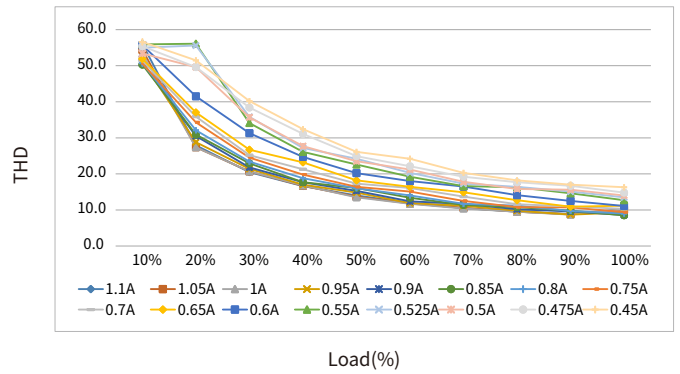

Power factor vs. Load

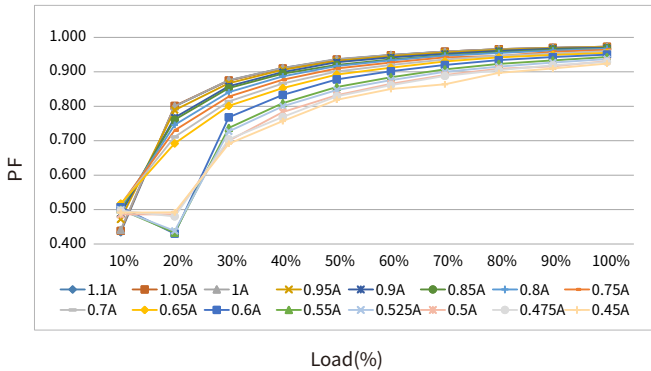

Displacement factor vs. Load

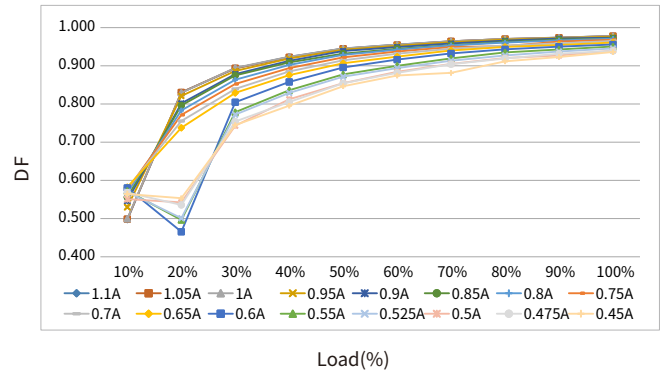

**Expected life-time**

Life-time vs. case temperature

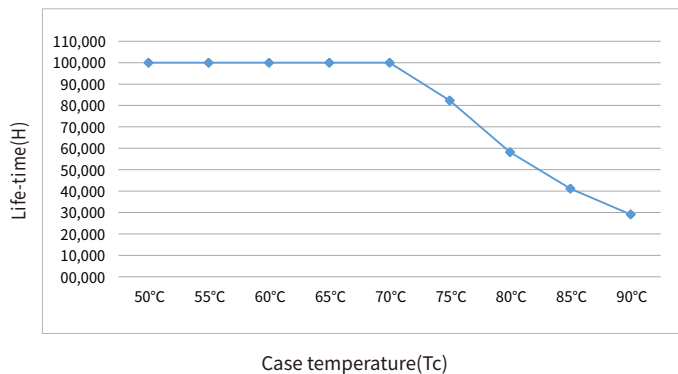

-The life-time of the LED driver is shown in the figure above (calculated based on the 90% survival rate).

- The relation of tc to ta temperature depends also on the luminaire design.

Electrical values

BK-DUL060-B2000ADP

Operating window

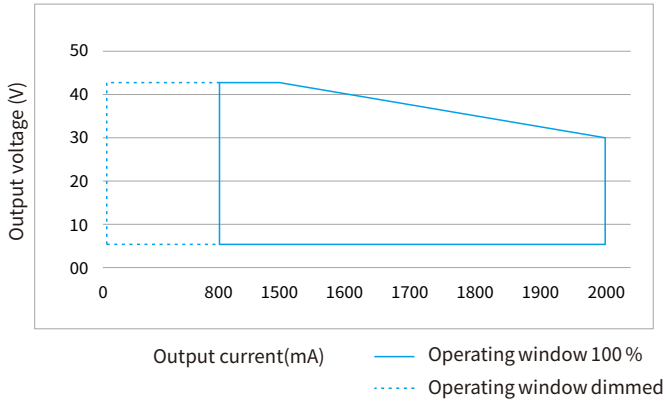

Operating window

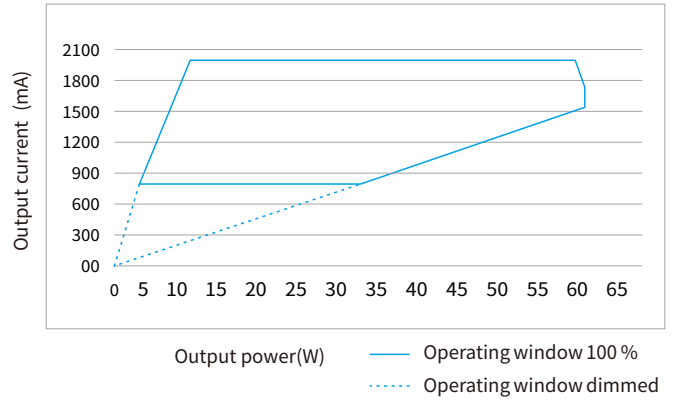

Efficiency vs load

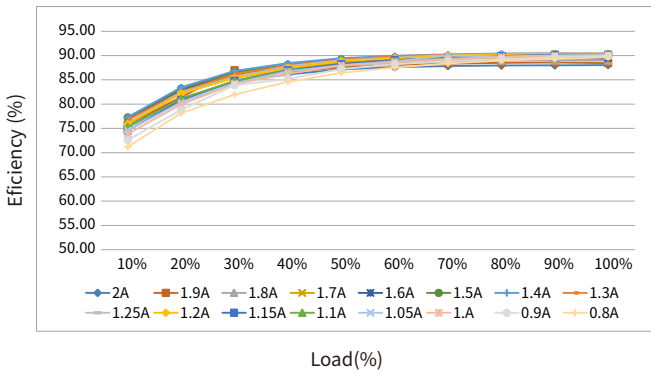

THD vs. Load

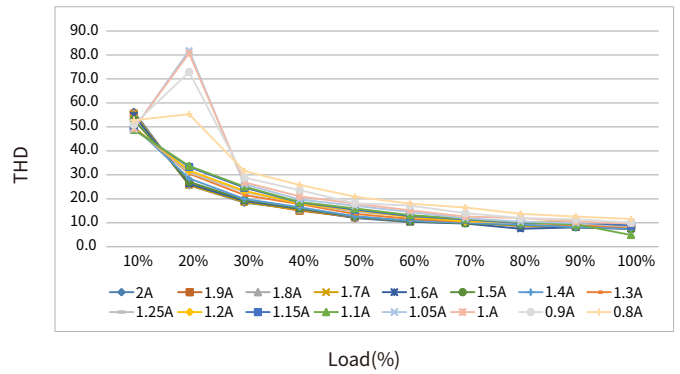

Power factor vs. Load

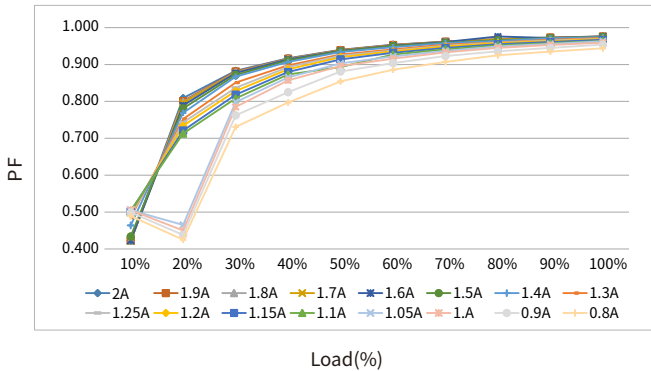

Displacement factor vs. Load

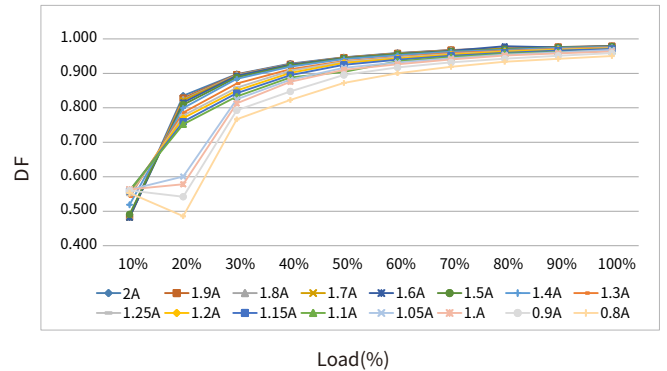

Expected life-time

Life-time vs. case temperature

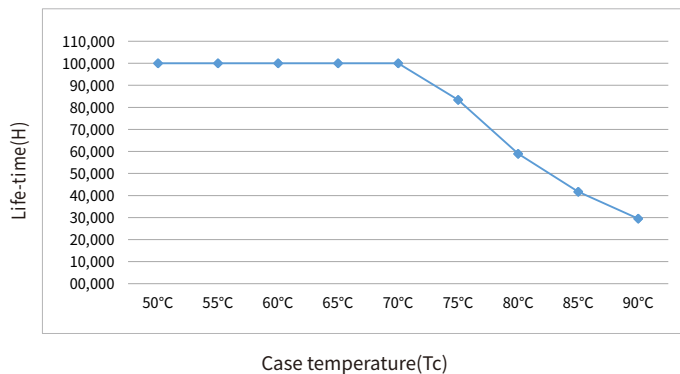

-The life-time of the LED driver is shown in the figure above (calculated based on the 90% survival rate).

- The relation of tc to ta temperature depends also on the luminaire design.

## Surge

Model	Ipeak	Twidth	Condition	Relative number of MCB/pcs														
				B10	B13	B16	B20	B25	C10	C13	C16	C20	C25	D10	D13	D16	D20	D25
BK-DUL010-B0350ADP	3.79A	170us	AC 230V, Full load, Cold start, Ta ≤ 30°C, MCB is not installed side by side	98	127	157	196	245	119	154	190	237	296	119	154	190	237	296
BK-DUL022-B0600ADP	6.28A	206us		48	62	77	96	120	57	74	91	113	142	57	74	91	113	142
BK-DUL028-B0750ADP	6.25A	212us		45	59	73	91	113	45	59	73	91	113	45	59	73	91	113
BK-DUL030-B0800ADP	7.6A	182us		43	56	69	87	108	43	56	69	87	108	43	56	69	87	108
BK-DUL042-B1100ADP	7.3A	188us		32	41	51	64	80	32	41	51	64	80	32	41	51	64	80
BK-DUL060-B2000ADP	14.4A	194us		22	28	35	44	55	22	28	35	44	55	22	28	35	44	55

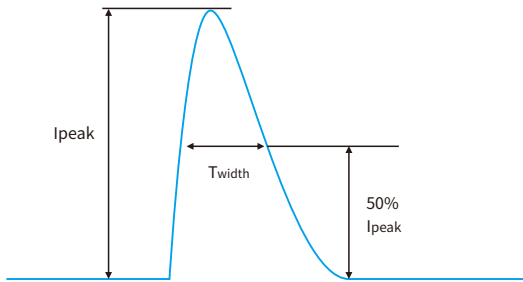

### Remarks

- The number of drives mounted under different MCBs in the table is the maximum value. Please do not exceed this number during installation.
- Calculation uses typical values from ABB series S200 as a reference.
- Different brands and models of miniature circuit breakers, the number of drives mounted will be slightly different.
- If the ambient temperature of the MCB installation exceeds 30°C or multiple MCBs are installed side by side, the number of drives mounted will be reduced and the calculation needs to be recalculated.
- Electrician's usually consider Type B for household lighting and Type C for commercial lighting application.

## Functions

### Output short-circuit behaviour

- Output short-circuit will not damage the driver.
- After removing the short circuit fault, the driver will automatically resume output.

### Output no-load operation

- Output no-load will not damage the driver.
- Please turn off the driver first if you need to connect the LED load.

### Output overload protection

- The LED driver turns off the output if the output voltage range is exceeded.
- The output will be activated again after restart the LED driver .

### Output hot plug-in

In the following two cases, the LED driver will automatically turn off the output to protect the LED:

- When the driver is powered on first and the LED is connected later.
- When the driver is powered on, disconnected and connected again.

The output will be activated again after restart of the LED driver .

### Driver restart method

There are two ways to restart the driver:

- Through the AC input: disconnect the AC of the driver and power it again.
- Through dimming interface.
- DALI: send "OFF" command first, then send "MAX" command.
- pushDIM: short press pushbutton two times, then long press pushbutton.
- 1-10V: first adjust the output voltage of the dimmer to 0.9V or below, then adjust it to 1V or above.

### Corridor dimming (corridorDIM)

- Please see the "corridorDIM dimming" section.

### Adjustable output current (AOC)

- The output current of the driver can be adjusted within a certain range, and 2 options can be selected through the EasySet configuration software.
- Setting 1 (default): By DIP-switch setting
- The output current is determined by the selection of the DIP-switch.
- Setting 2: By programming setting
- The output current is determined by the programming setting.

### Constant light output (CLO)

- The luminous flux of a LED decreases constantly over the life-time.
- The CLO function ensures that the emitted luminous flux remains stable. For that purpose the LED current will increase continuously over the LED life-time.
- In EasySet configuration it is possible to select a start value (in percent) and an expected life-time. The LED driver adjusts the current afterwards automatically.

### Emergency lighting (EL)

- The driver works normally under DC input.
- When the driver is applied in DC input, the positive pole of the DC cable should be connected to the ACL/DC+ terminal, and the negative pole of the DC cable should be connected to the ACN/DC- terminal. If the connection is reversed, the driver will not be damaged, but it will affect the EL function normal work.
- The output response action after DC input can be set through the EasySet configuration software.
- Setting 1 (default): When DC input, the output of the driver remains unchanged, and the dimming function responds normally.
- Setting 2: When DC input, the output of the driver jumps to the setting brightness, and the dimming function is invalid.

### Configuration programming (EasySet)

- The programming configuration of the driver is realized using the BOKE EasySet programming suite and through the driver's DALI interface.
- Please see the "Device configuration" section.
- More information about the EasySet programming suite can be found at [www.bokedriver.com](http://www.bokedriver.com).

**Label**

BK-DUL010-B0350ADP

**BOKE Dimmable Constant Current LED Driver**  
**MODEL: BK-DUL010-B0350ADP**  
 INPUT: 200-240V  $\approx$  0.5/0.60Hz 0.07A Max.  $\lambda$ : 0.45C-0.95  
 OUTPUT: 6-30V  $\approx$  350mA 10.5W 50VDC Max.  
 Other ratings see selection sheet  
 For LED Modules use only  
 www.bokedriver.com  
 MADE IN CHINA

•tc EasySet

wire prep. 0.75-1.5mm<sup>2</sup> Preparation for input and output  
 8-9mm tc:90°C ta:60°C

■ ACL/DC+ ■ ACN/DC- ■ DA ■ DA

pushDIM DALI

wire prep. 0.5-1.0mm<sup>2</sup>

Switching selection sheet

Output	Switch	1	2	3	4
4.20	100	6-42	ON	ON	ON
5.25	125	6-42	ON	ON	ON
6.30	150	6-42	ON	ON	ON
7.35	175	6-42	ON	ON	ON
8.40	200	6-42	ON	ON	ON
9.45	225	6-42	ON	ON	ON
10.5	250	6-42	ON	ON	ON
11.0	275	6-42	ON	ON	ON
10.8	300	6-36	ON	ON	ON
10.5	350	6-30	ON	ON	ON

For Australia and New Zealand, "the marking label with"

Before use, always check dipswitch settings!

BK-DUL022-B0600ADP

**BOKE Dimmable Constant Current LED Driver**  
**MODEL: BK-DUL022-B0600ADP**  
 INPUT: 200-240V  $\approx$  0.5/0.60Hz 0.14A Max.  $\lambda$ : 0.45C-0.95  
 OUTPUT: 6-38V  $\approx$  600mA 22.8W 50VDC Max.  
 Other ratings see selection sheet  
 For LED Modules use only  
 www.bokedriver.com  
 MADE IN CHINA

•tc EasySet

wire prep. 0.75-1.5mm<sup>2</sup> Preparation for input and output  
 8-9mm tc:90°C ta:50°C

■ ACL/DC+ ■ ACN/DC- ■ DA ■ DA

pushDIM DALI

wire prep. 0.5-1.0mm<sup>2</sup>

Switching selection sheet

Output	Switch	1	2	3	4
9.45	225	6-42	ON	ON	ON
10.50	250	6-42	ON	ON	ON
11.55	275	6-42	ON	ON	ON
12.60	300	6-42	ON	ON	ON
14.70	350	6-42	ON	ON	ON
16.80	400	6-42	ON	ON	ON
18.90	450	6-42	ON	ON	ON
21.00	500	6-42	ON	ON	ON
23.10	550	6-42	ON	ON	ON
22.80	600	6-38	ON	ON	ON

For Australia and New Zealand, "the marking label with"

Before use, always check dipswitch settings!

BK-DUL028-B0750ADP

**BOKE Dimmable Constant Current LED Driver**  
**MODEL: BK-DUL028-B0750ADP**  
 INPUT: 200-240V  $\approx$  0.5/0.60Hz 0.18A Max.  $\lambda$ : 0.45C-0.95  
 OUTPUT: 6-38V  $\approx$  750mA 28.5W 50VDC Max.  
 Other ratings see selection sheet  
 For LED Modules use only  
 www.bokedriver.com  
 MADE IN CHINA

•tc EasySet

wire prep. 0.75-1.5mm<sup>2</sup> Preparation for input and output  
 8-9mm tc:90°C ta:45°C

■ ACL/DC+ ■ ACN/DC- ■ DA ■ DA

pushDIM DALI

wire prep. 0.5-1.0mm<sup>2</sup>

Switching selection sheet

Output	Switch	1	2	3	4
12.60	300	6-42	ON	ON	ON
14.70	350	6-42	ON	ON	ON
16.80	400	6-42	ON	ON	ON
18.90	450	6-42	ON	ON	ON
21.00	500	6-42	ON	ON	ON
23.10	550	6-42	ON	ON	ON
25.20	600	6-42	ON	ON	ON
27.30	650	6-42	ON	ON	ON
28.00	700	6-40	ON	ON	ON
28.50	750	6-38	ON	ON	ON

For Australia and New Zealand, "the marking label with"

Before use, always check dipswitch settings!

**DIP-switch & output current**

BK-DUL010-B0350ADP

Output			1	2	3	4	Dimming depth
Prated(w)	Irated(mA)	Voltage(Vdc)					
4.20	100	6-42	--	ON	ON	ON	2%
5.25	125	6-42	ON	--	ON	ON	2%
6.30	150	6-42	--	--	ON	ON	2%
7.35	175	6-42	--	ON	--	ON	2%
8.40	200	6-42	--	--	--	ON	1%
9.45	225	6-42	ON	ON	ON	--	1%
10.5	250	6-42	--	--	ON	--	1%
11.0	275	6-40	--	ON	--	--	1%
10.8	300	6-36	ON	--	--	--	1%
10.5	350	6-30	--	--	--	--	1%

BK-DUL022-B0600ADP

Output			1	2	3	4	Dimming depth
Prated(w)	Irated(mA)	Voltage(Vdc)					
9.45	225	6-42	--	ON	ON	ON	1%
10.50	250	6-42	ON	--	ON	ON	1%
11.55	275	6-42	--	--	ON	ON	1%
12.60	300	6-42	--	ON	--	ON	1%
14.70	350	6-42	--	--	--	ON	1%
16.80	400	6-42	ON	ON	ON	--	1%
18.90	450	6-42	--	--	ON	--	1%
21.00	500	6-42	--	ON	--	--	1%
23.10	550	6-42	ON	--	--	--	1%
22.80	600	6-38	--	--	--	--	1%

BK-DUL028-B0750ADP

Output			1	2	3	4	Dimming depth
Prated(w)	Irated(mA)	Voltage(Vdc)					
12.60	300	6-42	--	ON	ON	ON	1%
14.70	350	6-42	ON	--	ON	ON	1%
16.80	400	6-42	--	--	ON	ON	1%
18.90	450	6-42	--	ON	--	ON	1%
21.00	500	6-42	--	--	--	ON	1%
23.10	550	6-42	ON	ON	ON	--	1%
25.20	600	6-42	--	--	ON	--	1%
27.30	650	6-42	--	ON	--	--	1%
28.00	700	6-40	ON	--	--	--	1%
28.50	750	6-38	--	--	--	--	1%

**Remarks:**

- ★ It means that this item is the factory default current.
- It means that this channel is OFF.

**Label**

BK-DUL030-B0800ADP

**ACL/DC+** **BOKE** www.bokedriver.com  
**Dimmable Constant Current LED Driver**  
**MODEL: BK-DUL030-B0800ADP**  
 INPUT: 200-240V  $\approx$  0.50/60Hz 0.18A Max  $\lambda$ : 0.45C-0.95  
 OUTPUT: 6-38V  $\approx$  800mA 30.4W 50VDC Max.  
 Other ratings see below sheet  
 Do not energize the driver before connecting the LED.

**DA** pushDIM L N DA DALLI  
 Do not energize the driver before connecting the LED.

**DA** wire prep. 0.75-1.5mm<sup>2</sup>  
 Preparation for input and output  
 8-9mm  
**DIM-**  
**DIM+**  
**LED+**  
**LED-**

wire prep. 0.5-1.0mm<sup>2</sup> MADE IN CHINA  
 For Australia and New Zealand, the marking label with " " Top view  
 For LED Modules use only  
 tc:90°C ta:45°C

Output		Switch				
Po(w)	Io(mA)	Uo(Vdc)	1	2	3	4
10.50	250	6-42	ON	ON	ON	ON
11.55	275	6-42	ON	ON	ON	ON
12.60	300	6-42	ON	ON	ON	ON
13.65	325	6-42	ON	ON	ON	ON
14.70	350	6-42	ON	ON	ON	ON
15.75	375	6-42	ON	ON	ON	ON
16.80	400	6-42	ON	ON	ON	ON
17.85	425	6-42	ON	ON	ON	ON
18.90	450	6-42	ON	ON	ON	ON
21.00	500	6-42	ON	ON	ON	ON
23.10	550	6-42	ON	ON	ON	ON
25.20	600	6-42	ON	ON	ON	ON
27.30	650	6-42	ON	ON	ON	ON
29.40	700	6-42	ON	ON	ON	ON
30.00	750	6-40	ON	ON	ON	ON
30.40	800	6-38	ON	ON	ON	ON

**DIP-switch & output current**

BK-DUL030-B0800ADP

Prated(w)	Irated(mA)	Voltage(Vdc)	Output				Dimming depth
			1	2	3	4	
10.50	250	6-42	ON	ON	ON	ON	1%
11.55	275	6-42	--	ON	ON	ON	1%
12.60	300	6-42	ON	--	ON	ON	1%
13.65	325	6-42	--	--	ON	ON	1%
14.70	350	6-42	ON	ON	--	ON	1%
15.75	375	6-42	--	ON	--	ON	1%
16.80	400	6-42	ON	--	--	ON	1%
17.85	425	6-42	--	--	--	ON	1%
18.90	450	6-42	ON	ON	ON	--	1%
21.00	500	6-42	--	ON	ON	--	1%
23.10	550	6-42	ON	--	ON	--	1%
25.20	600	6-42	--	--	ON	--	1%
27.30	650	6-42	ON	ON	--	--	1%
29.40	700	6-42	--	ON	--	--	1%
30.00	750	6-40	ON	--	--	--	1%
30.40	800	6-38	--	--	--	--	1%

BK-DUL042-B1100ADP

**ACL/DC+** **BOKE** www.bokedriver.com  
**Dimmable Constant Current LED Driver**  
**MODEL: BK-DUL042-B1100ADP**  
 INPUT: 200-240V  $\approx$  0.50/60Hz 0.25A Max  $\lambda$ : 0.45C-0.95  
 OUTPUT: 6-38V  $\approx$  1100mA 41.8W 50VDC Max.  
 Other ratings see below sheet  
 Do not energize the driver before connecting the LED.

**DA** pushDIM L N DA DALLI  
 Do not energize the driver before connecting the LED.

**DA** wire prep. 0.75-1.5mm<sup>2</sup>  
 Preparation for input and output  
 8-9mm  
**DIM-**  
**DIM+**  
**LED+**  
**LED-**

wire prep. 0.5-1.0mm<sup>2</sup> MADE IN CHINA  
 For Australia and New Zealand, the marking label with " " Top view  
 For LED Modules use only  
 tc:90°C ta:45°C

Output		Switch				
Po(w)	Io(mA)	Uo(Vdc)	1	2	3	4
18.90	450	6-42	ON	ON	ON	ON
19.95	475	6-42	ON	ON	ON	ON
21.00	500	6-42	ON	--	ON	ON
22.05	525	6-42	--	ON	ON	ON
23.10	550	6-42	ON	ON	--	ON
25.20	600	6-42	--	ON	--	ON
27.30	650	6-42	ON	--	--	ON
29.40	700	6-42	--	--	--	ON
31.50	750	6-42	ON	ON	ON	--
33.60	800	6-42	--	ON	ON	--
35.70	850	6-42	ON	--	ON	--
37.80	900	6-42	ON	--	ON	--
39.90	950	6-42	ON	ON	--	--
42.00	1000	6-42	--	ON	--	--
42.00	1050	6-40	ON	--	--	--
41.80	1100	6-38	--	--	--	--

BK-DUL042-B1100ADP

Prated(w)	Irated(mA)	Voltage(Vdc)	Output				Dimming depth
			1	2	3	4	
18.90	450	6-42	ON	ON	ON	ON	1%
19.95	475	6-42	--	ON	ON	ON	1%
21.00	500	6-42	ON	--	ON	ON	1%
22.05	525	6-42	--	--	ON	ON	1%
23.10	550	6-42	ON	ON	--	ON	1%
25.20	600	6-42	--	ON	--	ON	1%
27.30	650	6-42	ON	--	--	ON	1%
29.40	700	6-42	--	--	--	ON	1%
31.50	750	6-42	ON	ON	ON	--	1%
33.60	800	6-42	--	ON	ON	--	1%
35.70	850	6-42	ON	--	ON	--	1%
37.80	900	6-42	--	--	ON	--	1%
39.90	950	6-42	ON	ON	--	--	1%
42.00	1000	6-42	--	ON	--	--	1%
42.00	1050	6-40	ON	--	--	--	1%
41.80	1100	6-38	--	--	--	--	1%

BK-DUL060-B2000ADP

**ACL/DC+** **BOKE** www.bokedriver.com  
**Dimmable Constant Current LED Driver**  
**MODEL: BK-DUL060-B2000ADP**  
 INPUT: 200-240V  $\approx$  0.50/60Hz 0.36A Max  $\lambda$ : 0.45C-0.95  
 OUTPUT: 6-30V  $\approx$  2000mA 60W 50VDC Max.  
 Other ratings see below sheet  
 Do not energize the driver before connecting the LED.

**DA** pushDIM L N DA DALLI  
 Do not energize the driver before connecting the LED.

**DA** wire prep. 0.75-1.5mm<sup>2</sup>  
 Preparation for input and output  
 8-9mm  
**DIM-**  
**DIM+**  
**LED+**  
**LED-**

wire prep. 0.5-1.0mm<sup>2</sup> MADE IN CHINA  
 For Australia and New Zealand, the marking label with " " Top view  
 For LED Modules use only  
 tc:90°C ta:45°C

Output		Switch				
Po(w)	Io(mA)	Uo(Vdc)	1	2	3	4
33.6	800	6-42	ON	ON	ON	ON
37.8	900	6-42	ON	ON	ON	ON
42.0	1000	6-42	ON	--	ON	ON
44.1	1050	6-42	--	--	ON	ON
46.2	1100	6-42	ON	ON	--	ON
48.3	1150	6-42	--	ON	--	ON
50.4	1200	6-42	ON	--	--	ON
52.5	1250	6-42	--	--	--	ON
54.6	1300	6-42	ON	ON	ON	--
58.8	1400	6-42	--	ON	ON	--
60.0	1500	6-40	ON	--	ON	--
62.1	1600	6-38	--	--	ON	--
61.2	1700	6-36	ON	ON	--	--
61.2	1800	6-34	ON	ON	--	--
60.8	1900	6-32	ON	--	--	--
60.0	2000	6-30	--	--	--	--

BK-DUL060-B2000ADP

Prated(w)	Irated(mA)	Voltage(Vdc)	Output				Dimming depth
			1	2	3	4	
33.6	800	6-42	ON	ON	ON	ON	1%
37.8	900	6-42	--	ON	ON	ON	1%
42.0	1000	6-42	ON	--	ON	ON	1%
44.1	1050	6-42	--	--	ON	ON	1%
46.2	1100	6-42	ON	ON	--	ON	1%
48.3	1150	6-42	--	ON	--	ON	1%
50.4	1200	6-42	ON	--	--	ON	1%
52.5	1250	6-42	--	--	--	ON	1%
54.6	1300	6-42	ON	ON	ON	--	1%
58.8	1400	6-42	--	ON	ON	--	1%
60.0	1500	6-40	ON	--	ON	--	1%
60.8	1600	6-38	--	--	ON	--	1%
61.2	1700	6-36	ON	ON	--	--	1%
61.2	1800	6-34	--	ON	--	--	1%
60.8	1900	6-32	ON	--	--	--	1%
60.0	2000	6-30	--	--	--	--	1%

**Remarks:**

- ★ It means that this item is the factory default current.
- It means that this channel is OFF.

**Insulation between circuits**

Isolation	Input	Output	Case	DALI	PUSH	DIM	PWM
Input	-	Double	Double	Basic	-	Basic	Double
Output	Double	-	Basic	Double	Double	-	-
Case	Double	Basic	-	Double	Double	Basic	Basic

**Optional accessories (See the parts specification for details)**

**DUL010,DUL022,DUL028:**

Optional 1: Wiring type

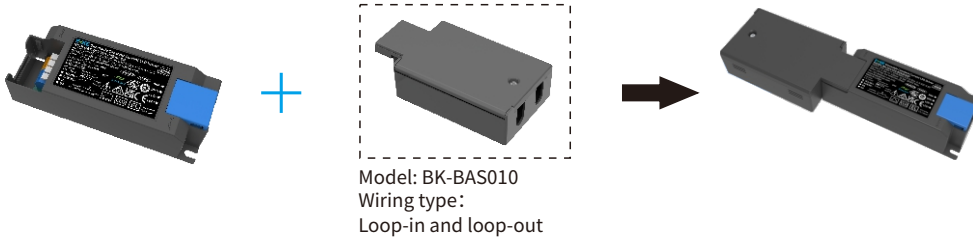

Optional2: Pluggable connector type,5Pole(WAGO)

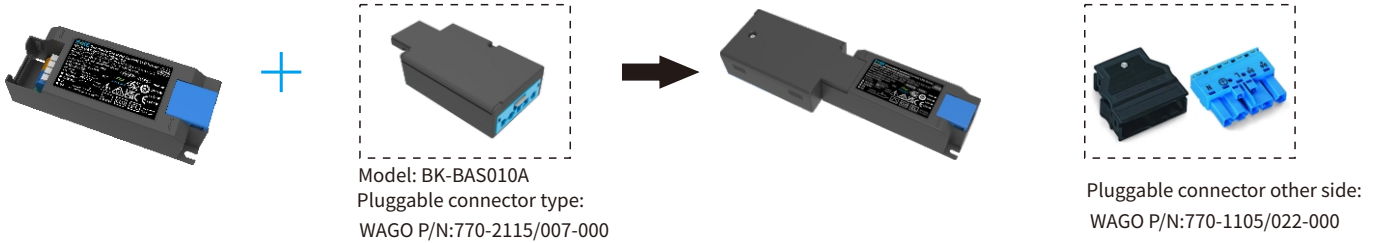

Optional3: Pluggable connector type,5Pole(Wieland)

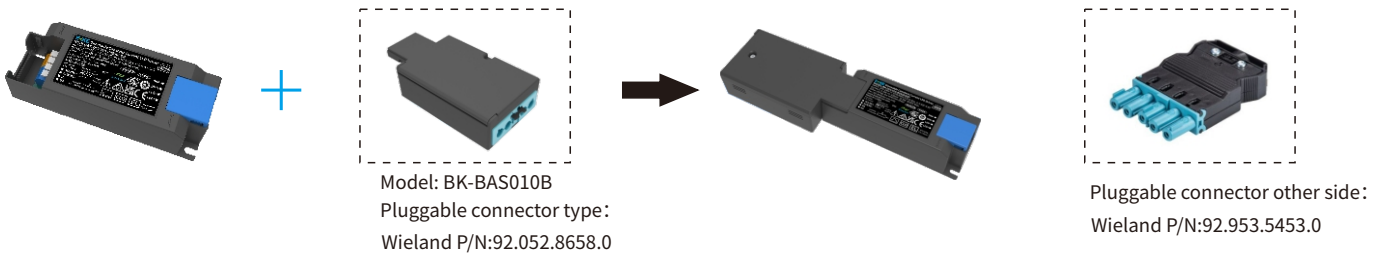

**DUL030,DUL042,DUL060:**

Optional 1: Wiring type

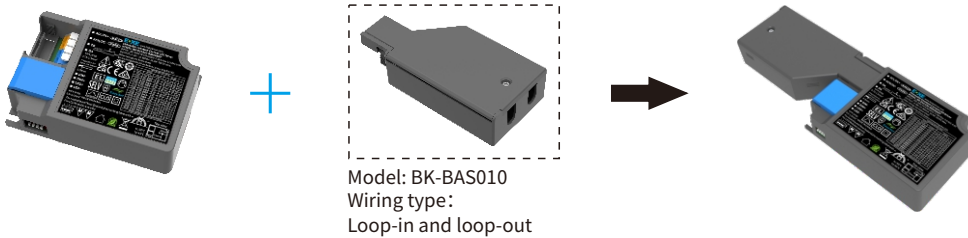

Optional2: Pluggable connector type,5Pole(WAGO)

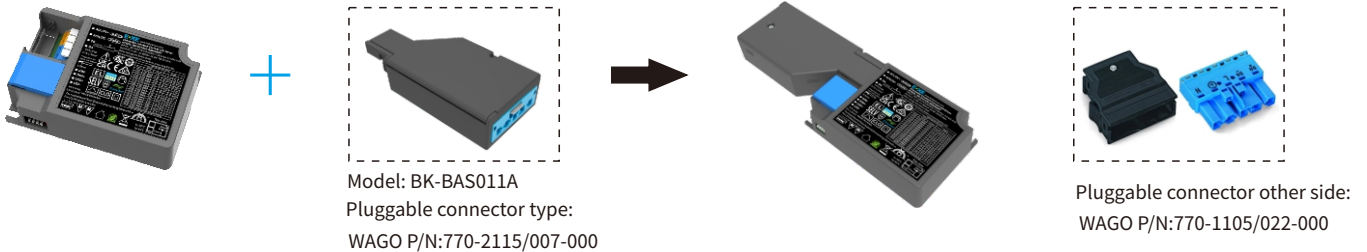

Optional3: Pluggable connector type,5Pole(Wieland)

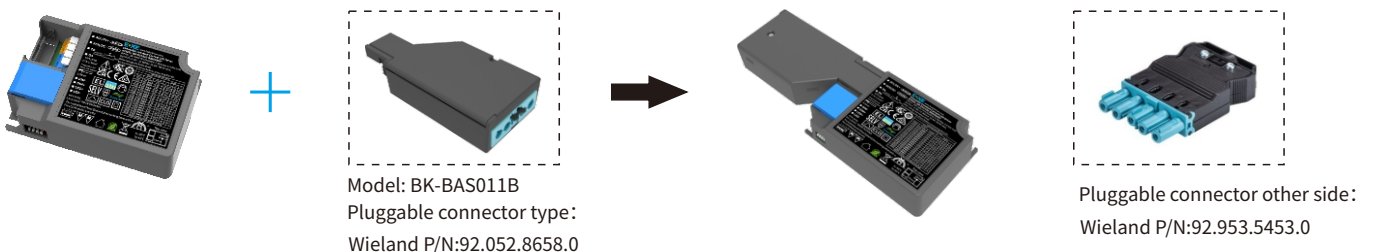

## DALI dimming application

### Wiring diagram

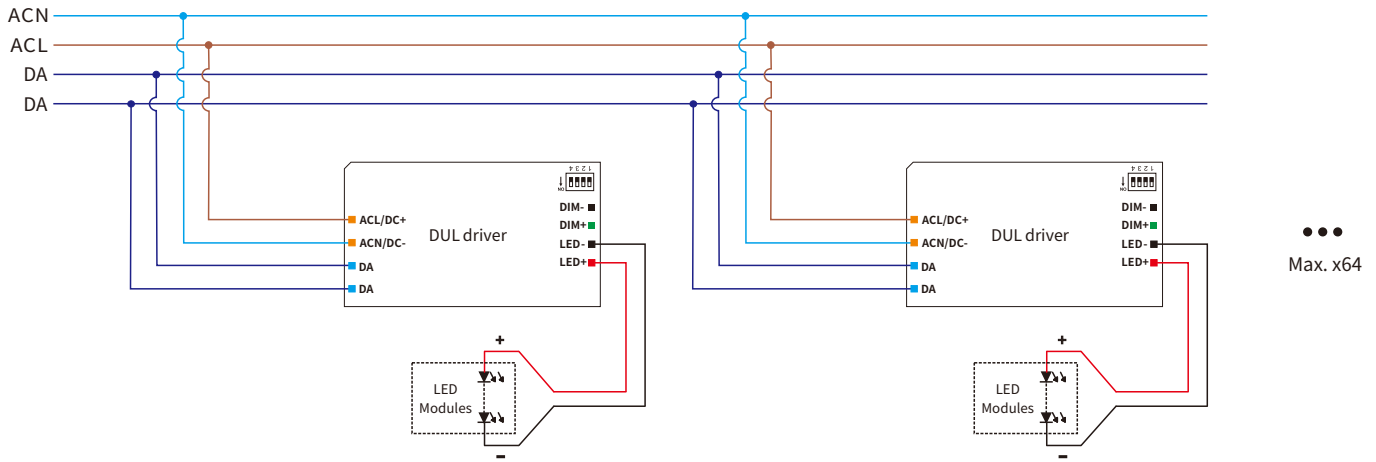

### Switch to the DALI dimming mode

- After installation according to the wiring diagram of DALI dimming application, the driver will automatically switch to the DALI control mode after receiving any DALI command.

#### Remarks:

- Standard DALI control line voltage range: 9.5V to 22.5V, type 16V.
- The two DALI control lines polarity-reversible.
- Max. 64 DALI drivers per DALI control line.
- The maximum distance length of the DALI control line is 300m at  $2 \times 1.5\text{mm}^2$ .
- DALI bus can be wired together with any mains voltage cables, but separate wiring is recommended.
- The configuration parameters of the driver can be set through the DALI configuration tool or DALI application controller during installation, such as setting device address, group address, power-on level, bus-failure level, scene level, fade time, dimming curve, etc.

Please refer to the table below

Cable size	Distance
$2 \times 0.50\text{mm}^2$	max.100m
$2 \times 0.75\text{mm}^2$	max.150m
$2 \times 1.00\text{mm}^2$	max.200m
$\geq 2 \times 1.50\text{mm}^2$	max.300m

#### Power-on level :

When the driver is in DALI-2 dimming mode, the factory default level after each power-on is the brightest.

The power-on level can be set through the DALI configuration tool or DALI application controller during installation, and can be set to memory or fixed any brightness (such as off, darkest, 50%, etc.).

Note: The recommended setting for the default factory power-on level of the DALI-2 driver is the brightest in the DALI-2 standard.

### Dimming curve

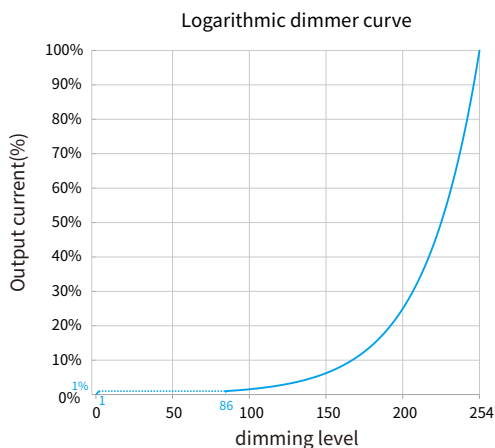

Remarks: The dimming curve can be selected by DALI configuration. The default is logarithmic dimming curve.

**pushDIM dimming application**

**Wiring diagram**

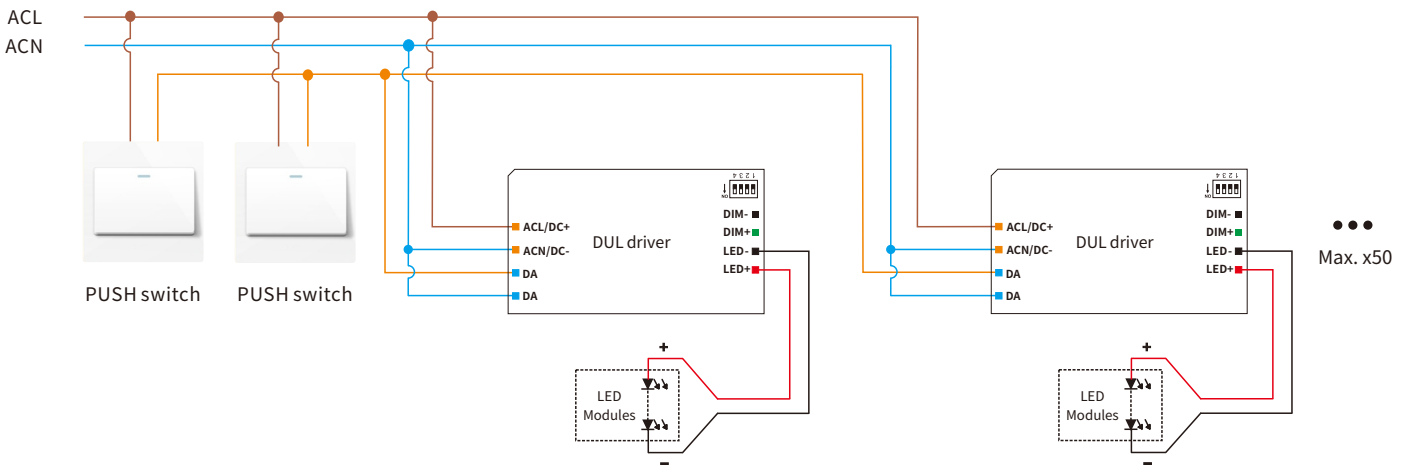

**Switch to the pushDIM dimming mode**

- According to the wiring diagram of the pushDIM dimming application, short press(<1s) the pushbutton 5 times quickly within 3s , then long press(>1s) the pushbutton 1 time,The driver will automatically switch to the pushDIM dimming mode.
- After switch to the pushDIM control mode, CorridorDIM mode will be automatically closed.

**Remarks:**

Max. 50 drivers per pushDIM control line.

Turn on or turn off:short press pushbutton for 0.2-1s.

Dimming: long press pushbutton for 1-5s.

Power on status: after power on,the light state will be the same as the lighting on state.

If the light is on before power on,the light will be on after power on again,brightness will be the same as the last lighting on brightness.

If the light is off before power off,the light will be off after power on again,short press the pushbutton,then the light will be on,the brightness will be the same as the last brightness.

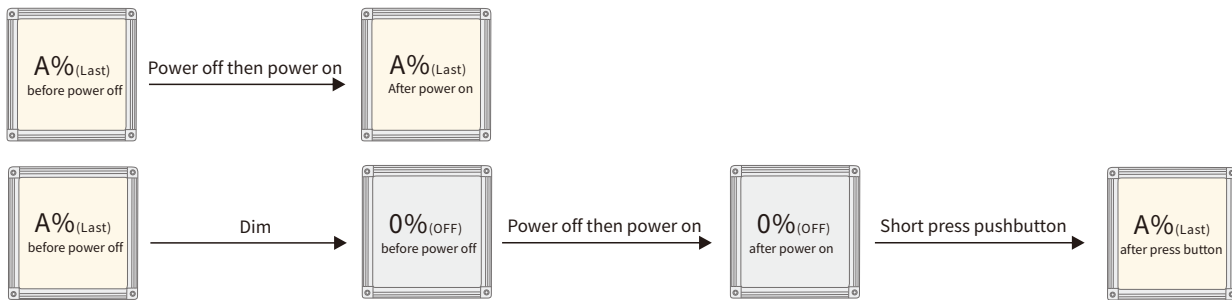

**Multiple lights synchronize control operation**

method 1:

Step 1:long press the pushbutton,confirm each light is on.

Step 2:short press the pushbutton,confirm each light is off.

Step 3:long press the pushbutton,confirm each light is from darkest to brightest and all the lights are synchronous.

method 2:

- Long press the pushbutton 15s,all lights output to the brightest state.

## 1-10V/10V PWM dimming application

### Wiring diagram

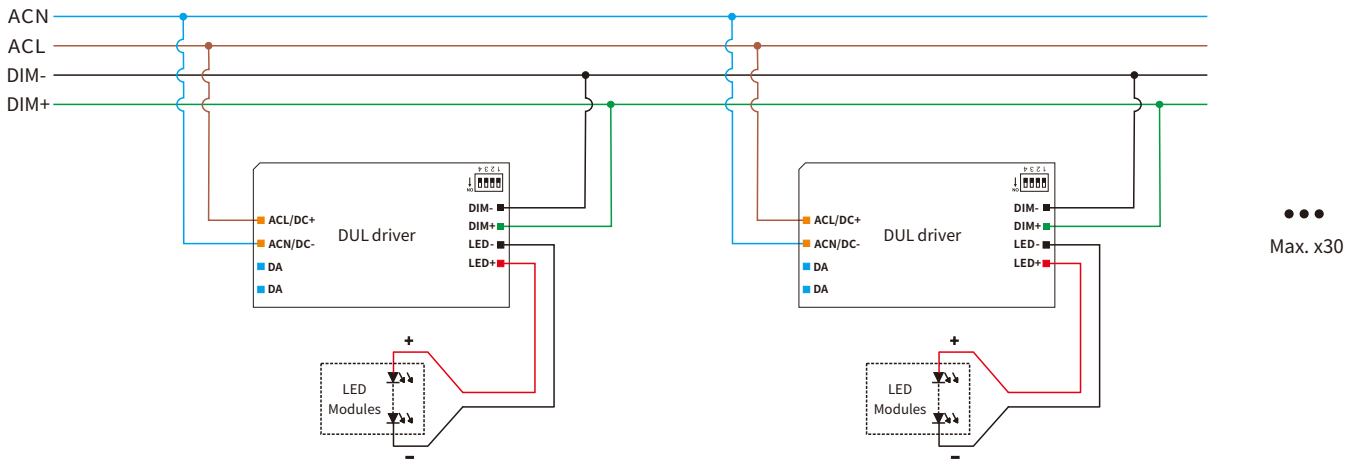

### Switch to the 1-10V / 10V PWM dimming mode

- Method 1: After installation according to the wiring diagram of the 1-10V / 10V PWM dimming application, adjust the dimmer to the minimum and then to the maximum, the driver will automatically activate the 1-10V control mode.
- Method 2: Short-circuit the DIM+ and DIM- ports for 2s, the driver will automatically activate the 1-10V control mode.

#### Remarks:

- Dimming interface characteristics: 0.9V and below are closed, 1V is the darkest, 10V is the brightest, 1-10V is the dimming range.
- The dimming interface distinguishes between positive and negative, DIM is positive, GND is negative, please do not reverse.
- Dimming interface does not support voltage access higher than 20V, otherwise it will cause damage to the internal components.
- When the dimming interface is open, the driver outputs the maximum current. When the interface is short-circuited, the current output is closed.
- When multiple synchronous dimming is required, the positive poles of the dimming interface of each driver are connected together, and the negative poles are connected together.
- Support passive dimmer or isolated active dimmer dimming, does not support non-isolated active dimmer dimming.
- In general, it is recommended that the number of mounted drives does not exceed 30pcs, and the wiring length does not exceed 100m.
- It is recommended that the dimming wires should not be lower than the 22AWG wire.
- Do not put the dimming wires with high voltage or interference sources. If it is unavoidable, please use the shielded wires.
- It is recommended to conduct sample test first and confirm the dimming effect before bulk purchase.
- If you need a drive with 0-10V dimming characteristics, please contact BOKE.

### Dimming curve

Output current vs. Dimming Voltage(Typical)

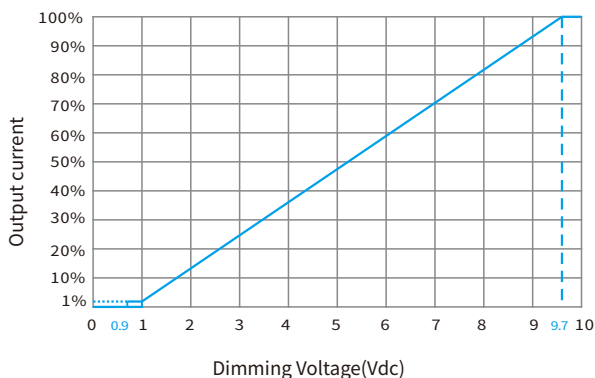

Output current 10V PWM Duty Cycle(Typical)

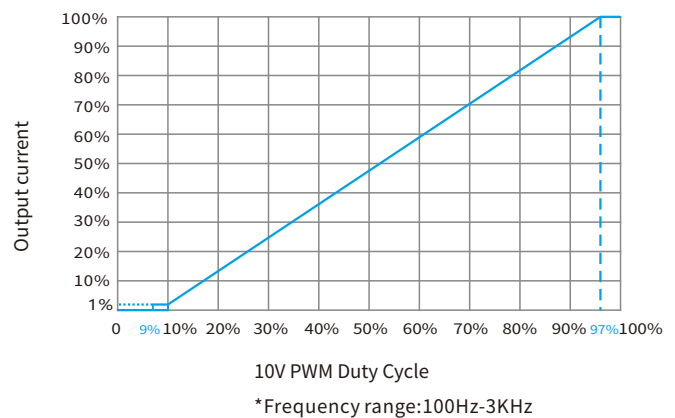

## 100K potentiometer dimming application

### Wiring diagram

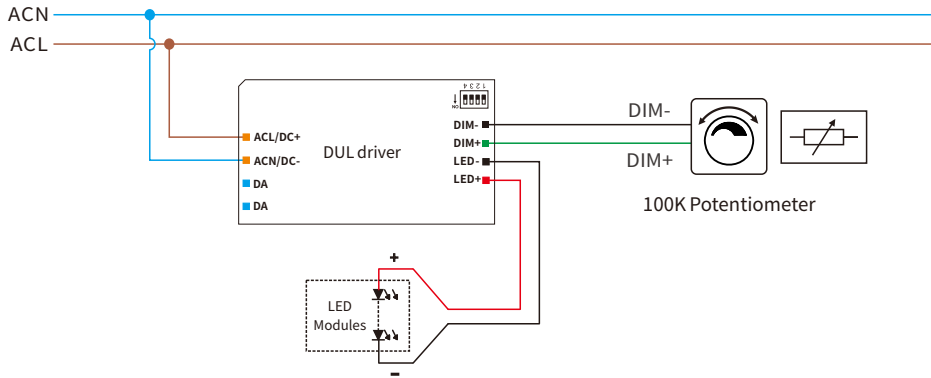

### Remarks:

- Only one driver can be mounted in the potentiometer dimming mode.
- Dimming interface does not support voltage access higher than 20V, otherwise it will cause damage to the internal components.
- When the dimming interface is open, the driver outputs the maximum current. When the interface is short-circuited, the current output is closed.
- It is recommended that the dimming wires should not be lower than the 22AWG wire.
- Do not put the dimming wires with high voltage or interference sources. If it is unavoidable, please use the shielded wires.
- It is recommended to conduct sample test first and confirm the dimming effect before bulk purchase.
- If you need a drive with 0-10V dimming characteristics, please contact BOKE.

### Dimming curve

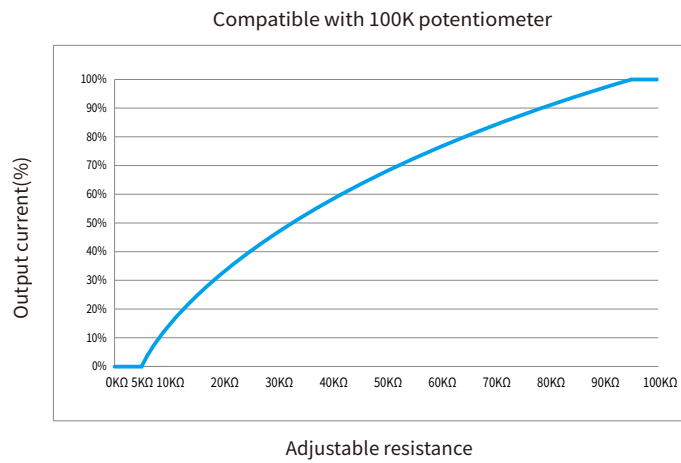

**corridorDIM dimming application**

**Wiring diagram**

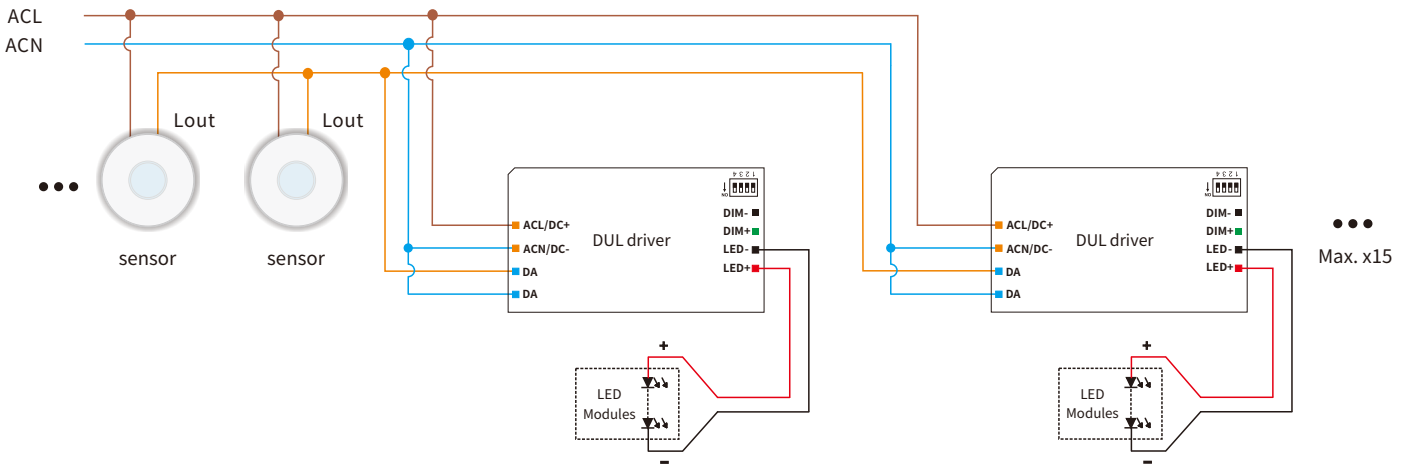

**Switch to the corridorDIM dimming mode**

- Method 1: Switch by sensor.

After installation according to the wiring diagram of corridorDIM dimming application, you can use the following two methods to switched.

Method 1: Keep the movement in the effective sensing area for 5 minutes, the corridorDIM dimming function of the driver will be switched and light up 100% (under the default setting).

Method 2: Switch by Hold-time

Set the hold-time of the sensor to more than 5 minutes. When the motion sensor detects a person and turns on the output for 5 minutes, the corridorDIM dimming function will be switched and the light will be on 100% (Default), finally restore the hold-time that the sensor actually needs.

-Method 2: Switch by normal switch

After installation according to the wiring diagram of the corridorDIM dimming application, first replace the sensor with a normal switch, and then turn on the normal switch for 5 minutes, and the driver will automatically switch to corridorDIM dimming mode, then remove the normal switch and replace it with the sensor.

- After switch to the corridorDIM dimming mode, the pushDIM dimming mode will be automatically deactivate .

**Remarks**

- During normal working,It is recommended to set the hold-time of the motion sensor to the minimum.
- Need to use a motion sensor with AC switch.

**corridorDIM working process**

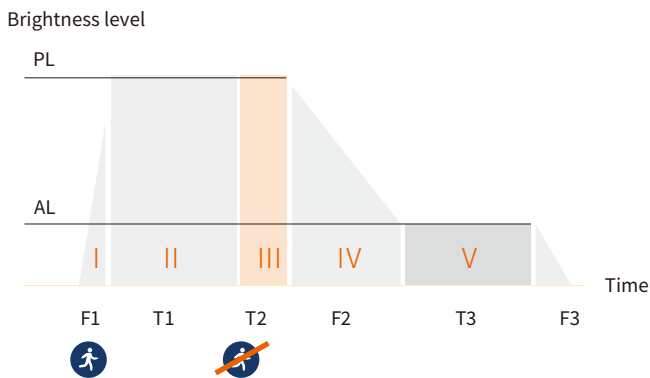

Name	Symbol	Factory setting	Settable range
Fade-in time	F1	1s	0-100s
Presence level	PL	100%	0-100%
Hold-on time	T1	By sensor setting	
Run-on time	T2	180s	0-60000s
Fade-out time	F2	5s	0-100s
Absence level	AL	10%	0-100%
Stand-by Time	T3	unlimited	0-59999s,60000s(unlimited)
Fade-off time	F3	0s	0-100s

- The parameters of corridorDIM can be set through the configuration tool.
- corridorDIM is not activated by default.

**Device configuration**

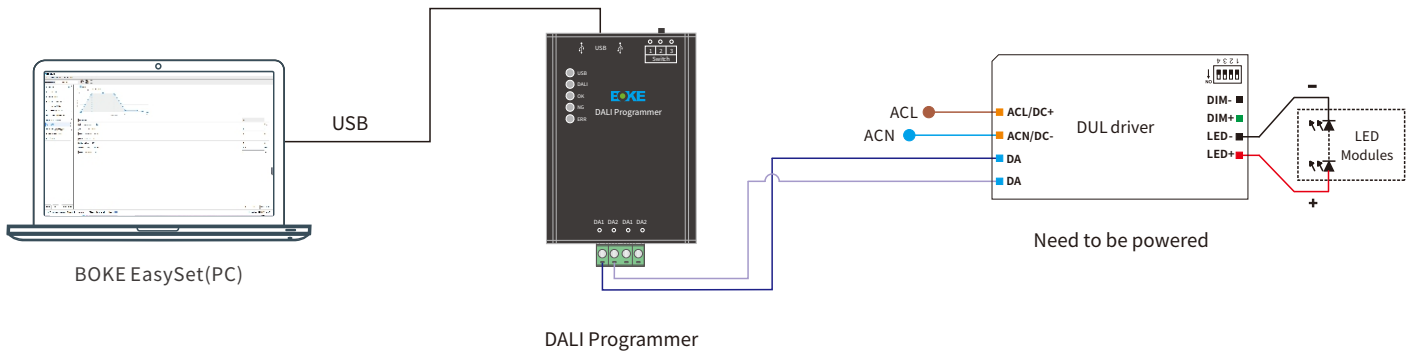

**Software download(PC)**



Note: PC supports Windows 7/Windows 10/Windows 11 32bit/64bit.

**Device configuration**

**Configure tools and software**

Type	Name	Brand	Name	Minimum version
Programmer	DALI programmer	BOKE	BK-CS01-SDL	V1.0.0
Software	PC Software	BOKE	BOKE EasySet	V1.0.0

**Parameters configure**

Configuration items	Factory settings	Parameter configuration	Read/Wirte
Product information	-	NO	Read Only
Adjustable output current(AOC)	Activated	YES	Read/Wirte
PUSH dimming function(pushDIM)	Activated	YES	Read/Wirte
1-10V dimming (1-10V)	Activated	YES	Read/Wirte
Corridor dimming(corridorDIM)	Activated	YES	Read/Wirte
Emergency lighting(EL)	Activated(setting 1)	YES	Read/Wirte
Constant light output function(CLO)	Deactivated	YES	Read/Wirte
DALI address/programming	Activated	YES	Read/Wirte
DALI parameter(DT6)	Activated	YES	Read/Wirte
DALI scene(DT6)	Activated	YES	Read/Wirte
Hot plug-in protection(HPP)	Activated	YES	Read/Wirte
Running time		NO	Read Only
Other parameters		YES	

**Mechanical Specification**

Size(Excluding accessories)

Unit:mm

DUL010-B

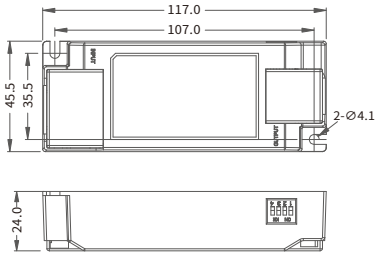

DUL022-B/DUL028-B

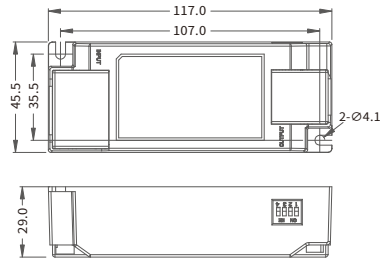

DUL030-B/DUL042-B

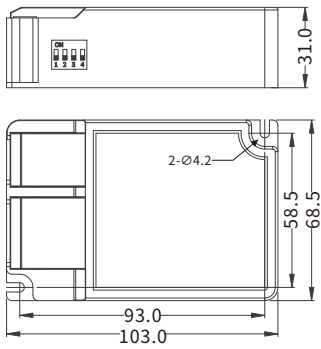

DUL060-B

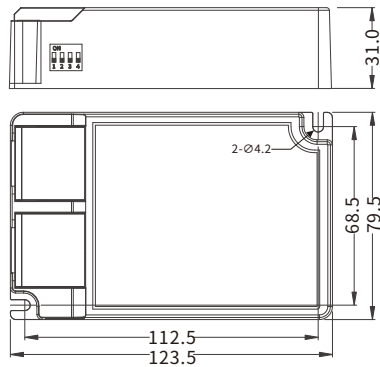

**Mechanical Specification**

Size(Include accessories)

Unit:mm

DUL010-B/DUL022-B/DUL028-B

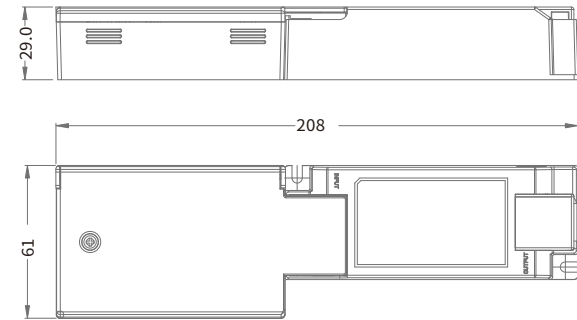

DUL030-B/DUL042-B



DUL060-B

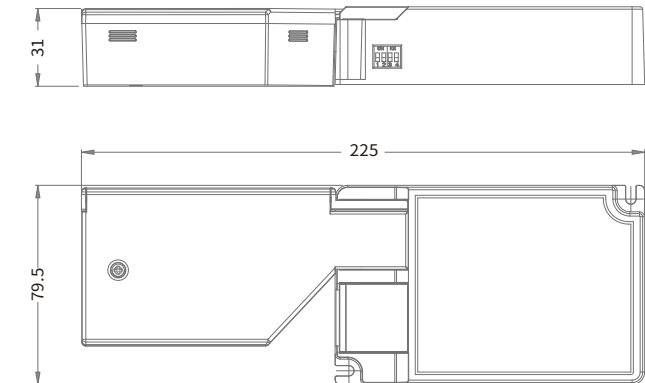

**INPUT**

Numbering	function	colour
1	ACL/DC+	orange
2	ACN/DC-	orange
3	DA	blue
4	DA	blue

Input wire

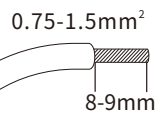

**OUTPUT**

Numbering	function	colour
1	DIM-	black
2	DIM+	green
3	LED-	black
4	LED+	red

Output wire

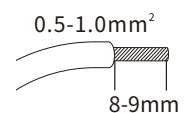

**Installation note**

**Hot plug-in**

- Hot plug-in is not supported due to residual output voltage of > 0 V.
- If a LED load is connected the device has to be restarted.
- Restart can be achieved by re-powering the driver or executing a on/off command (action) through the control interface (DALI, pushDIM,1-10V)

**Wiring guidelines**

- All connections must be kept as short as possible to ensure good EMI behaviour.
- Mains leads should be kept apart from LED Driver and other leads (ideally 5 – 10 cm distance)
- Max. length of output wires is 2 m.
- Incorrect wiring can damage LED modules.

**Installation requirements**

- The driver should be installed in a dry, acid-free, oil-free, fat-free environment.
- The installation ambient temperature of the drive shall not exceed the value of Ta at any time.
- The temperature of the mounting surface of the driver should be lower than 40°C
- The driver should keep a certain distance from the heating stuff (such as the luminaire radiator).
- If the driver is used externally (it needs to be used with the accessories), the installation of the driver should also meet the following conditions:
  - 1.The driver should be a certain distance between the drivers, as shown in Figure 1.
  - 2.The driver keeps a certain distance from surrounding objects, as shown in Figure 2.
  - 3.Two power outputs cannot be connected in parallel.

**Mounting screw specifications and torque**

- Max. torque at the clamping screw: 0.5 Nm / M4

**Replace LED module**

1. Mains off
2. Remove LED module
3. Wait for 5 seconds
4. Connect LED module again

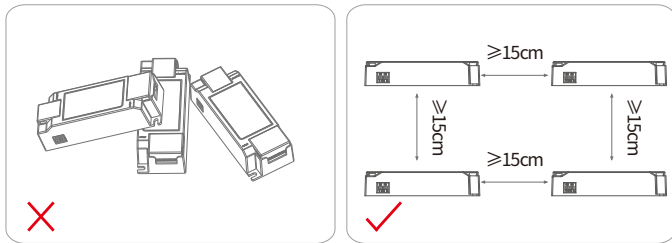

Figure 1

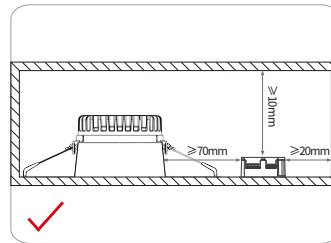
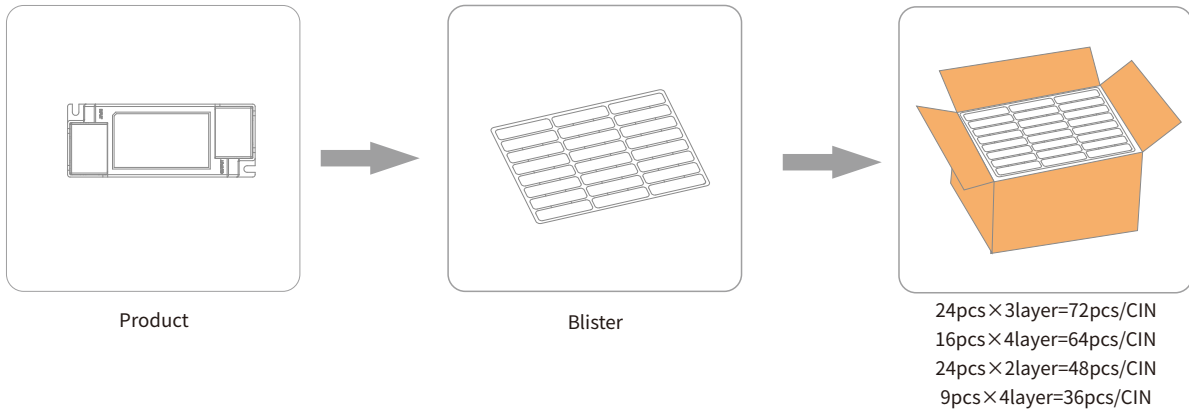

Figure 2

**Packaging**

**Optional 1: factory default**



Model	Product size	Weight	Blister size	Carton size	Qty/carton	N.W	G.W
DUL010-B	L117*W45.5*H24mm	85g	L430*W340*H47mm	L450*W350*H180mm	72pcs	6.12kg	7.10kg
DUL022-B	L117*W45.5*H29mm	110g	L430*W340*H47mm	L450*W350*H180mm	72pcs	7.92kg	8.90kg
DUL028-B	L117*W45.5*H29mm	170g	L430*W340*H47mm	L450*W350*H130mm	48pcs	8.16kg	9.17kg
DUL030-B	L103*W68.5*H31mm	140g	L480*W330*H40mm	L490*W340*H165mm	64pcs	8.96kg	9.98kg
DUL042-B	L103*W68.5*H31mm	165g	L480*W330*H40mm	L490*W340*H165mm	64pcs	10.6kg	11.8kg
DUL060-B	L123*W78.5*H31mm	240g	L435*W345*H40mm	L450*W350*H180mm	36pcs	8.64kg	9.84kg

**Optional 2:**

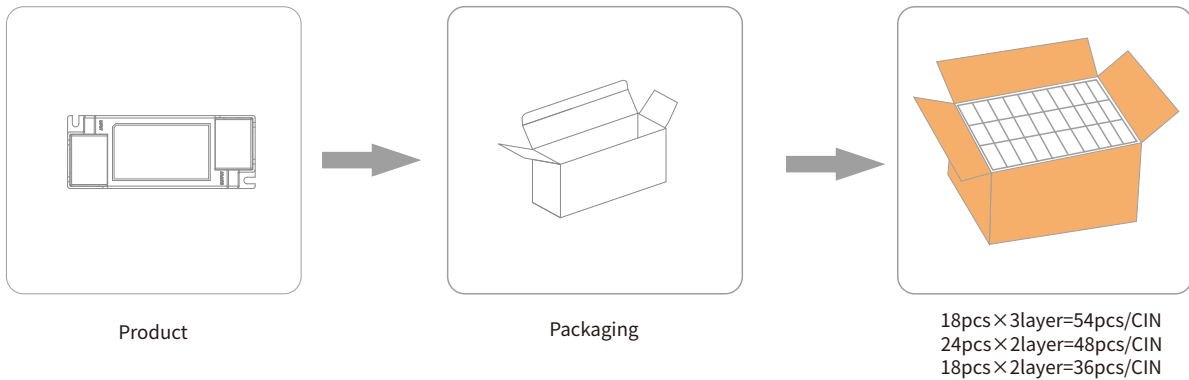

Model	Product size	Weight	Packaging size	Carton size	Qty/carton	N.W	G.W
DUL010-B	L117*W45.5*H24mm	85g	L140*W35*H50mm	L345*W310*H170mm	54pcs	4.59kg	6.10kg
DUL022-B	L117*W45.5*H29mm	110g	L140*W35*H50mm	L345*W310*H170mm	54pcs	5.94kg	7.38kg
DUL028-B	L117*W45.5*H29mm	170g	L140*W35*H50mm	L345*W310*H170mm	54pcs	9.18kg	10.6kg
DUL030-B	L103*W68.5*H31mm	140g	L130*W38*H85mm	L415*W330*H190mm	48pcs	6.72kg	7.82kg
DUL042-B	L103*W68.5*H31mm	165g	L130*W38*H85mm	L415*W330*H190mm	48pcs	7.92kg	9.11kg
DUL060-B	L123*W79.5*H31mm	240g	L140*W40*H100mm	L380*W295*H220mm	36pcs	8.64kg	9.84kg

**Additional information**

1. This product can only be used outside the light body, Can not be used inside of the light, and it must be used within the specified working environment.
2. The life and MTBF of the product are for reference only, and do not represent a warranty statement.
3. For more information, please send an email to [info@bokedriver.com](mailto:info@bokedriver.com).

**Packaging(Include accessories)**



Model	Product size	Weight	Packaging size	Carton size	Qty/carton	N.W	G.W
DUL010-B	L208*W61*H29mm	136g	L230*W40*H80mm	L415*W290*H255mm	35pcs	4.47kg	6.32kg
DUL022-B	L208*W61*H29mm	162g	L230*W40*H80mm	L415*W290*H255mm	35pcs	5.67kg	6.93kg
DUL028-B	L208*W61*H29mm	215g	L230*W40*H80mm	L415*W290*H255mm	35pcs	7.53kg	8.85kg
DUL030-B	L204*W68.5*H31mm	192g	L230*W40*H80mm	L415*W290*H255mm	35pcs	6.72kg	7.98kg
DUL042-B	L204*W68.5*H31mm	221g	L230*W40*H80mm	L415*W290*H255mm	35pcs	7.74kg	8.99kg
DUL060-B	L225*W79.5*H31mm	308g	L245*W40*H90mm	L345*W260*H290mm	24pcs	7.39kg	8.60kg

**Additional information**

1. This product can only be used outside the light body, Can not be used inside of the light, and it must be used within the specified working environment.
2. The life and MTBF of the product are for reference only, and do not represent a warranty statement.
3. For more information, please send an email to [info@bokedriver.com](mailto:info@bokedriver.com).